

Hypertherm[®]

powermax65[®]

powermax85[®]

Plasma arc cutting systems



Operator Manual – 806650

Revision 0

Register your new Hypertherm system

Register your product on-line at www.hypertherm.com/registration for easier technical and warranty support. You can also receive updates on new Hypertherm products and a free gift as a token of our appreciation.

For your records

Serial number: _____

Purchase date: _____

Distributor: _____

Maintenance notes:

powermax65
powermax85

Operator Manual
(P/N 806650)

Revision 0 – September 2010

Hypertherm, Inc.
Hanover, NH USA
www.hypertherm.com
email: info@hypertherm.com

© Copyright 2010 Hypertherm, Inc.
All Rights Reserved

Hypertherm and Powermax are trademarks of Hypertherm, Inc.
and may be registered in the United States and/or other countries.

Hypertherm, Inc.

Etna Road, P.O. Box 5010
Hanover, NH 03755 USA
603-643-3441 Tel (Main Office)
603-643-5352 Fax (All Departments)
info@hypertherm.com (Main Office Email)
800-643-9878 Tel (Technical Service)
technical.service@hypertherm.com (Technical Service Email)
800-737-2978 Tel (Customer Service)
customer.service@hypertherm.com (Customer Service Email)

Hypertherm Automation

5 Technology Drive, Suite 300
West Lebanon, NH 03784 USA
603-298-7970 Tel
603-298-7977 Fax

Hypertherm Plasmatechnik GmbH

Technologiepark Hanau
Rodenbacher Chaussee 6
D-63457 Hanau-Wolfgang, Deutschland
49 6181 58 2100 Tel
49 6181 58 2134 Fax
49 6181 58 2123 (Technical Service)

Hypertherm (S) Pte Ltd.

82 Genting Lane
Media Centre
Annexe Block #A01-01
Singapore 349567, Republic of Singapore
65 6841 2489 Tel
65 6841 2490 Fax
65 6841 2489 (Technical Service)

Hypertherm (Shanghai) Trading Co., Ltd.

Unit A, 5th Floor, Careri Building
432 West Huai Hai Road
Shanghai, 200052
PR China
86-21 5258 3330/1 Tel
86-21 5258 3332 Fax

Hypertherm Europe B.V.

Vaartveld 9
4704 SE
Roosendaal, Nederland
31 165 596907 Tel
31 165 596901 Fax
31 165 596908 Tel (Marketing)
31 165 596900 Tel (Technical Service)
00 800 4973 7843 Tel (Technical Service)

Hypertherm Japan Ltd.

Level 9, Edobori Center Building
2-1-1 Edobori, Nishi-ku
Osaka 550-0002 Japan
81 6 6225 1183 Tel
81 6 6225 1184 Fax

Hypertherm Brasil Ltda.

Avenida Doutor Renato de
Andrade Maia 350
Parque Renato Maia
CEP 07114-000
Guarulhos, SP Brasil
55 11 2409 2636 Tel
55 11 2408 0462 Fax

Hypertherm México, S.A. de C.V.

Avenida Toluca No. 444, Anexo 1,
Colonia Olivar de los Padres
Delegación Álvaro Obregón
México, D.F. C.P. 01780
52 55 5681 8109 Tel
52 55 5683 2127 Fax

EMC Introduction

Hypertherm's CE-marked equipment is built in compliance with standard EN60974-10. The equipment should be installed and used in accordance with the information below to achieve electromagnetic compatibility.

The limits required by EN60974-10 may not be adequate to completely eliminate interference when the affected equipment is in close proximity or has a high degree of sensitivity. In such cases it may be necessary to use other measures to further reduce interference.

This cutting equipment is designed for use only in an industrial environment.

Installation and use

The user is responsible for installing and using the plasma equipment according to the manufacturer's instructions. If electromagnetic disturbances are detected then it shall be the responsibility of the user to resolve the situation with the technical assistance of the manufacturer. In some cases this remedial action may be as simple as earthing the cutting circuit, see *Earthing of Workpiece*. In other cases it could involve constructing an electromagnetic screen enclosing the power source and the work complete with associated input filters. In all cases electromagnetic disturbances must be reduced to the point where they are no longer troublesome.

Assessment of area

Before installing the equipment the user shall make an assessment of potential electromagnetic problems in the surrounding area. The following shall be taken into account:

- a. Other supply cables, control cables, signalling and telephone cables; above, below and adjacent to the cutting equipment.

- b. Radio and television transmitters and receivers.
- c. Computer and other control equipment.
- d. Safety critical equipment, for example guarding of industrial equipment.
- e. Health of the people around, for example the use of pacemakers and hearing aids.
- f. Equipment used for calibration or measurement.
- g. Immunity of other equipment in the environment. User shall ensure that other equipment being used in the environment is compatible. This may require additional protection measures.
- h. Time of day that cutting or other activities are to be carried out.

The size of the surrounding area to be considered will depend on the structure of the building and other activities that are taking place. The surrounding area may extend beyond the boundaries of the premises.

Methods of reducing emissions

Mains supply

Cutting equipment must be connected to the mains supply according to the manufacturer's recommendations. If interference occurs, it may be necessary to take additional precautions such as filtering of the mains supply. Consideration should be given to shielding the supply cable of permanently installed cutting equipment, in metallic conduit or equivalent. Shielding should be electrically continuous throughout its length. The shielding should be connected to the cutting mains supply so that good electrical contact is maintained between the conduit and the cutting power source enclosure.

Maintenance of cutting equipment

The cutting equipment must be routinely maintained according to the manufacturer's recommendations. All access and service doors and covers should be closed and properly fastened when the cutting equipment is in operation. The cutting equipment should not be modified in any way except for those changes and adjustments covered in the manufacturer's instructions. In particular, the spark gaps of arc striking and stabilizing devices should be adjusted and maintained according to the manufacturer's recommendations.

Cutting cables

The cutting cables should be kept as short as possible and should be positioned close together, running at or close to the floor level.

Equipotential bonding

Bonding of all metallic components in the cutting installation and adjacent to it should be considered. However, metallic components bonded to the workpiece will increase the risk that the operator could receive a shock by touching these metallic components and the electrode (nozzle for laser heads) at the same time. The operator should be insulated from all such bonded metallic components.

Earthing of workpiece

Where the workpiece is not bonded to earth for electrical safety, nor connected to earth because of its size and position, for example, ship's hull or building steelwork, a connection bonding the workpiece to earth may reduce emissions in some, but not all instances. Care should be taken to prevent the earthing of the workpiece increasing the risk of injury to users, or damage to other electrical equipment. Where necessary, the connection of the

workpiece to earth should be made by a direct connection to the workpiece, but in some countries where direct connection is not permitted, the bonding should be achieved by suitable capacitances selected according to national regulations.

Note: the cutting circuit may or may not be earthed for safety reasons. Changing the earthing arrangements should only be authorized by a person who is competent to assess whether the changes will increase the risk of injury, for example, by allowing parallel cutting current return paths which may damage the earth circuits of other equipment. Further guidance is given in IEC/ TS 62081 Arc Welding Equipment Installation and Use.

Screening and shielding

Selective screening and shielding of other cables and equipment in the surrounding area may alleviate problems of interference. Screening of the entire plasma cutting installation may be considered for special applications.

Attention

Genuine Hypertherm parts are the factory-recommended replacement parts for your Hypertherm system. Any damage caused by the use of other than genuine Hypertherm parts may not be covered by the Hypertherm warranty.

You are responsible for the safe use of the Product. Hypertherm does not and cannot make any guarantee or warranty regarding the safe use of the Product in your environment.

General

Hypertherm, Inc. warrants that its Products shall be free from defects in materials and workmanship, if Hypertherm is notified of a defect (i) with respect to the power supply within a period of two (2) years from the date of its delivery to you, with the exception of Powermax brand power supplies, which shall be within a period of three (3) years from the date of delivery to you, and (ii) with respect to the torch and leads within a period of one (1) year from its date of delivery to you, and with respect to torch lifter assemblies within a period of one (1) year from its date of delivery to you, and with respect to laser heads within a period of one (1) year from its date of delivery to you. This warranty shall not apply to any Powermax brand power supplies that have been used with phase converters. In addition, Hypertherm does not warranty systems that have been damaged as a result of poor power quality, whether from phase converters or incoming line power. This warranty shall not apply to any Product which has been incorrectly installed, modified, or otherwise damaged. Hypertherm, at its sole option, shall repair, replace, or adjust, free of charge, any defective Products covered by this warranty which shall be returned with Hypertherm's prior authorization (which shall not be unreasonably withheld), properly packed, to Hypertherm's place of business in Hanover, New Hampshire, or to an authorized Hypertherm repair facility, all

costs, insurance and freight prepaid. Hypertherm shall not be liable for any repairs, replacement, or adjustments of Products covered by this warranty, except those made pursuant to this paragraph or with Hypertherm's prior written consent. **The warranty above is exclusive and is in lieu of all other warranties, express, implied, statutory, or otherwise with respect to the Products or as to the results which may be obtained therefrom, and all implied warranties or conditions of quality or of merchantability or fitness for a particular purpose or against infringement. The foregoing shall constitute the sole and exclusive remedy for any breach by Hypertherm of its warranty.** Distributors/OEMs may offer different or additional warranties, but Distributors/OEMs are not authorized to give any additional warranty protection to you or make any representation to you purporting to be binding upon Hypertherm.

Certification test marks

Certified products are identified by one or more certification test marks from accredited testing laboratories. The certification test marks are located on or near the data plate. Each certification test mark means that the product and its safety-critical components conform to the relevant national safety standards as reviewed by that testing laboratory. Hypertherm places a certification test mark on its products only after that product is manufactured with safety-critical components that have been authorized by the accredited testing laboratory.

Once the product has left the Hypertherm factory, the certification test marks are invalidated if any of the following occurs:

- The product is significantly modified in a manner that creates a hazard or non-conformance.
- Safety-critical components are replaced with unauthorized spare parts.

WARRANTY

- Any unauthorized assembly or accessory that uses or generates a hazardous voltage is added.
- There is any tampering with a safety circuit or other feature that is designed into the product as part of the certification.

CE marking constitutes a manufacturer's declaration of conformity to applicable European directives and standards. Only those versions of Hypertherm products with a CE Marking located on or near the data plate have been tested for compliance with the European Low Voltage Directive and the European EMC Directive. EMC filters needed to comply with the European EMC Directive are incorporated within versions of the power supply with a CE Marking.

Differences in National Standards

Differences in standards include, but are not limited to:

- Voltages
- Plug and cord ratings
- Language requirements
- Electromagnetic compatibility requirements

These differences in national standards may make it impossible or impractical for all certification test marks to be placed on the same version of a product. For example, the CSA versions of Hypertherm's products do not comply with European EMC requirements and they do not have a CE marking on the data plate.

Countries that require CE marking or have compulsory EMC regulations must use CE versions of Hypertherm products with the CE marking on the data plate. These include:

- Australia
- New Zealand
- Countries in the European Union
- Russia

It is important that the product and its certification test mark be suitable for the end-use installation site. When Hypertherm products are shipped to one country for export to another country, the product must be configured and certified properly for the end-use site.

Higher-level systems

When a system integrator adds additional equipment; such as cutting tables, motor drives, motion controllers or robots; to a Hypertherm plasma cutting system, the combined system may be considered a higher-level system. A higher-level system with hazardous moving parts may constitute industrial machinery or robotic equipment, in which case the OEM or end-use customer may be subject to additional regulations and standards than those relevant to the plasma cutting system as manufactured by Hypertherm.

It is the responsibility of the end-use customer and the OEM to perform a risk assessment for the higher-level system and to provide protection against hazardous moving parts. Unless the higher-level system is certified when the OEM incorporates Hypertherm products into it, the installation also may be subject to approval by local authorities. Seek advice from legal counsel and local regulatory experts if uncertain about compliance.

External interconnecting cables between component parts of the higher level system must be suitable for contaminants and movement as required by the final end-use installation site. When the external interconnecting cables are subject to oil, dust, or water contaminants, hard usage ratings may be required. When external interconnecting cables are subject to continuous movement, constant flexing ratings may be required. It is the responsibility of the end-use customer or the OEM to ensure the cables are suitable for the application. Since there are differences in the

ratings and costs that can be required by local regulations for higher-level systems, it is necessary to verify that any external interconnecting cables are suitable for the end-use installation site.

Patent indemnity

Except only in cases of products not manufactured by Hypertherm or manufactured by a person other than Hypertherm not in strict conformity with Hypertherm's specifications and in cases of designs, processes, formulae, or combinations not developed or purported to be developed by Hypertherm, Hypertherm will defend or settle, at its own expense, any suit or proceeding brought against you alleging that the use of the Hypertherm product, alone and not in combination with any other product not supplied by Hypertherm, infringes any patent of any third party. You shall notify Hypertherm promptly upon learning of any action or threatened action in connection with any such alleged infringement, and Hypertherm's obligation to indemnify shall be conditioned upon Hypertherm's sole control of, and the indemnified party's cooperation and assistance in, the defense of the claim.

Limitation of liability

In no event shall Hypertherm be liable to any person or entity for any incidental, consequential, indirect, or punitive damages (including but not limited to lost profits) regardless of whether such liability is based on breach of contract, tort, strict liability, breach of warranties, failure of essential purpose or otherwise and even if advised of the possibility of such damages.

Liability cap

In no event shall Hypertherm's liability, whether such liability is based on breach of contract, tort, strict liability, breach of warranties, failure of essential purpose or otherwise, for any claim action suit or proceeding arising out of or relating to the

use of the Products exceed in the aggregate the amount paid for the Products that gave rise to such claim.

Insurance

At all times you will have and maintain insurance in such quantities and types, and with coverage sufficient and appropriate to defend and to hold Hypertherm harmless in the event of any cause of action arising from the use of the Products.

National and Local codes

National and Local codes governing plumbing and electrical installation shall take precedent over any instructions contained in this manual.

In no event shall Hypertherm be liable for injury to persons or property damage by reason of any code violation or poor work practices.

Transfer of rights

You may transfer any remaining rights you may have hereunder only in connection with the sale of all or substantially all of your assets or capital stock to a successor in interest who agrees to be bound by all of the terms and conditions of this Warranty.

Proper disposal of Hypertherm products

Hypertherm plasma cutting systems, like all electronic products, may contain materials or components, such as printed circuit boards, that cannot be discarded with ordinary waste. It is your responsibility to dispose of any Hypertherm product or component part in an environmentally acceptable manner according to national and local codes.

- In the United States, check all federal, state, and local laws.
- In the European Union, check the EU directives, national, and local laws. For more information, visit www.hypertherm.com/weee.
- In other countries, check national and local laws.

Section 1**Specifications**

System description.....	1-2
Where to find information	1-3
Power supply dimensions	1-4
Component weights.....	1-5
Powermax65 power supply ratings	1-6
Powermax85 power supply ratings	1-8
H65/H85 75° hand torch dimensions	1-10
H65s/H85s 15° hand torch dimensions	1-10
M65/M85 full-length machine torch dimensions.....	1-11
M65m/M85m mini-machine torch dimensions	1-11
Powermax65 cutting specifications.....	1-12
Powermax85 cutting specifications.....	1-13
Symbols and markings.....	1-14
IEC symbols	1-15

Section 2**Power Supply Setup**

Unpack the Powermax65 or Powermax85 system	2-2
Claims	2-2
Contents.....	2-3
Position the power supply.....	2-4
Prepare the electrical power	2-4
Install a line-disconnect switch	2-5
Requirements for grounding	2-5
Power connection for the Powermax65	2-6
Single-phase power cord (not for CE model).....	2-7
Three-phase power cord — plug installation.....	2-7

TABLE OF CONTENTS

Power connection for the Powermax85	2-8
Single-phase power cord (not for CE model).....	2-9
Single-phase power cord installation	2-10
Three-phase power cord — plug installation.....	2-11
Extension cord recommendations.....	2-11
Extension cord specifications.....	2-12
Engine-driven generator recommendations	2-13
Prepare the gas supply.....	2-14
Additional gas filtration.....	2-14
Connect the gas supply.....	2-15

Section 3

Torch Setup

Introduction	3-3
Consumable life.....	3-3
Hand torch setup	3-4
Choose the hand torch consumables	3-5
Hand torch consumables	3-6
Install the hand torch consumables.....	3-7
Machine torch setup.....	3-8
Converting an M65/M85 torch to an M65m/M85m torch	3-9
Mount the torch.....	3-11
Choose the machine torch consumables.....	3-14
Machine torch consumables.....	3-14
Install the machine torch consumables	3-17
Aligning the torch	3-17
Connecting an optional remote-start pendant	3-18
Connecting an optional machine interface cable.....	3-19
Connecting the torch lead.....	3-24

Using the cut charts	3-25
Estimated kerf-width compensation.....	3-26
85 A shielded consumables	3-28
65 A shielded consumables	3-32
45 A shielded consumables	3-36
FineCut® consumables.....	3-40
85 A unshielded consumables.....	3-43
65 A unshielded consumables.....	3-47
45 A unshielded consumables.....	3-51

Section 4

Operation

Controls and indicators	4-3
Rear controls	4-3
Front controls and LEDs.....	4-3
Status screen	4-6
Operating the Powermax65 or Powermax85	4-9
Connect the electrical power, gas supply, and torch lead	4-9
Attach the work lead to the power supply.....	4-10
Attach the work clamp to the workpiece	4-11
Turn ON the system.....	4-12
Set the operating mode switch	4-12
Check the indicators.....	4-13
Manually adjusting the gas pressure.....	4-13
Adjusting the current (amperage).....	4-14
Understanding duty-cycle limitations.....	4-15
Using the hand torch.....	4-16
Operate the safety trigger	4-16
Hand torch cutting hints	4-17
Start a cut from the edge of the workpiece.....	4-18
Pierce a workpiece.....	4-19
Gouge a workpiece	4-20
Common hand-cutting faults	4-23

TABLE OF CONTENTS

Using the machine torch	4-24
Ensure the torch and table are set up correctly	4-24
Understand and optimize cut quality.....	4-24
To pierce a workpiece using the machine torch	4-27
Common machine-cutting faults.....	4-27

Section 5

Maintenance and Repair

Perform routine maintenance	5-2
Inspect the consumables	5-3
Basic troubleshooting.....	5-4
Fault codes and solutions	5-6
Replace the gas filter element	5-10

Section 6

Parts

Power supply parts.....	6-2
Hand torch replacement parts	6-5
H65/H85	6-5
H65s/H85s.....	6-5
Hand torch consumables	6-8
Machine torch replacement parts	6-9
M65/M85/M65m/M85m	6-9
Machine torch consumables.....	6-12
Accessory parts.....	6-14
Powermax65/85 labels.....	6-15

Section 1

SPECIFICATIONS

In this section:

System description.....	1-2
Where to find information	1-3
Power supply dimensions	1-4
Component weights.....	1-5
Powermax65 power supply ratings	1-6
Powermax85 power supply ratings	1-8
H65/H85 75° hand torch dimensions	1-10
H65s/H85s 15° hand torch dimensions	1-10
M65/M85 full-length machine torch dimensions.....	1-11
M65m/M85m mini-machine torch dimensions	1-11
Powermax65 cutting specifications.....	1-12
Powermax85 cutting specifications.....	1-13
Symbols and markings.....	1-14
IEC symbols.....	1-15

SPECIFICATIONS

System description

The Powermax65 and Powermax85 are highly portable, 65-amp and 85-amp, handheld and mechanized plasma cutting systems appropriate for a wide range of applications. The Powermax systems use air or nitrogen to cut electrically conductive metals, such as mild steel, stainless steel, or aluminum. Smart Sense™ technology automatically adjusts the gas pressure according to cutting mode and torch lead length for optimum cutting.

The Powermax65 can cut thicknesses up to 1 inch (25 mm) with a handheld torch and pierce thicknesses up to .5 inch (12 mm) with a mechanized torch. The Powermax85 can cut thicknesses up to 1.25 inches (32 mm) and pierce thicknesses up to .75 inch (20 mm). FastConnect™ provides a simple push-button torch connection to the power supply for quick torch changes.

The typical handheld Powermax system includes a Duramax™ series H65 or H85 hand torch with a complete set of the consumables needed for cutting (shield, retaining cap, nozzle, electrode, swirl ring), a consumables box (containing 2 spare electrodes, 2 spare nozzles, 1 gouging nozzle, and 1 gouging shield), and a work cable. Reference materials include: operator manual, quick setup card, registration card, setup DVD, and safety manual.

The typical mechanized Powermax system includes a Duramax series M65 or M85 machine torch with a complete set of the consumables needed for cutting (shield, retaining cap, nozzle, electrode, swirl ring), a consumables box (containing 2 spare electrodes and 2 spare nozzles), work cable, and remote-start pendant. Reference materials include: operator manual, quick setup card, registration card, setup DVD, and safety manual.

You can order additional styles of torches, consumables, and accessories – such as the plasma cutting guide – from any Hypertherm distributor. See Section 6, *Parts*, for a list of spare and optional parts.

Powermax65 and Powermax85 power supplies are shipped without a plug on the power cord. See “Prepare the electrical power” on page 2-4 for more information.

Where to find information

System specifications such as size, weight, detailed electrical specifications, and cut speeds can be found in this section. For information on:

- Setup requirements, including power requirements, grounding, power cord configurations, extension cord requirements, and generator recommendations — see Section 2, *Power Supply Setup*.
- Handheld and machine torch consumables, cut charts, and torch setup information — see Section 3, *Torch Setup*.
- Information about the controls and LEDs, steps for system operation, and hints for improving cut quality — see Section 4, *Operation*.
- Routine maintenance and repair — see Section 5, *Maintenance and Repair*.
- Part numbers and ordering information for accessories, consumables, and replacement parts — see Section 6, *Parts*.

SPECIFICATIONS

Power supply dimensions

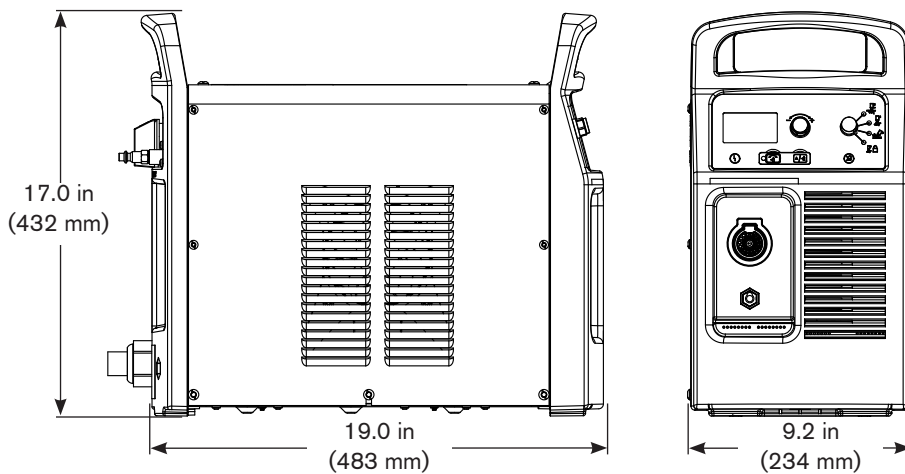

Component weights

	65 A CSA	65 A CE	85 A CSA	85 A CE
	lbs (kg)	lbs (kg)	lbs (kg)	lbs (kg)
Power supply	54.1 (24.5)	47.0 (21.3)	59.9 (27.2)	50.4 (22.8)

	65/85 A
	lbs (kg)
Hand torch 25 ft (7.6 m)	6.8 (3.1)
Hand torch 50 ft (15 m)	12.2 (5.5)
Hand torch 75 ft (23 m)	17.6 (8.0)

Machine torch 25 ft (7.6 m)	7.6 (3.4)
Machine torch 50 ft (15 m)	13.2 (6.0)
Machine torch 75 ft (23 m)	18.8 (8.5)

	65 A	85 A
	lbs (kg)	lbs (kg)
Work lead 25 ft (7.6 m)	2.8 (1.3)	6.8 (3.1)
Work lead 50 ft (15 m)	5.0 (2.3)	7.5 (3.4)
Work lead 75 ft (23 m)	6.9 (3.1)	10.6 (4.8)

SPECIFICATIONS

Powermax65 power supply ratings

Rated open-circuit voltage (U_0) CSA, 1-phase, 3-phase CE, 3-phase	CSA 296 VDC CE 270 VDC		
Output characteristic ¹	Drooping		
Rated output current (I_2)	20 – 65 A		
Rated output voltage (U_2)	139 VDC		
Duty cycle at 40° C (104° F) (See data plate on power supply for more information on duty cycle.)	CSA	50% @ 65 A, 230 – 600 V, 1/3 PH 40% @ 65 A, 200 – 208 V, 1/3 PH 100% @ 46 A, 230 – 600 V, 1/3 PH	
	CE	50% @ 65 A, 380/400 V, 3 PH 100% @ 46 A, 380/400 V, 3 PH	
Operating temperature	14° to 104° F (-10° to 40° C)		
Storage temperature	-13° to 131° F (-25° to 55° C)		
Power factor 200 – 480 V CSA, 1-phase 200 – 600 V CSA, 3-phase 380/400 V CE, 3-phase	0.99 – 0.97 0.94 – 0.73 0.94		
R_{sce} – Short Circuit Ratio (CE models only)	U_1 – Volts AC rms, 3PH	R_{sce}	
	400 VAC	225.7	
EMC classification CISPR 11 (CE models only) ⁴	Class A		
Input voltage (U_1)/ Input current (I_1) at rated output (U_2 I_{2MAX} , I_{1MAX}) (See Section 2, <i>Power Supply Setup</i> for more information.)	CSA	200/208/240/480 V, 1 PH, 50/60 Hz 52/50/44/22 A 200/208/240/480/600 V, 3 PH, 50/60 Hz 32/31/27/13/13 A	
	CE ^{2,3}	380/400 V, 3 PH, 50/60 Hz 15.5/15 A	
Gas type	Air		Nitrogen
Gas quality	Clean, dry, oil-free per ISO 8573-1 Class 1.2.2		99.95% pure
Recommended gas inlet flow rate/pressure	Cutting: 400 scfh , 6.7 scfm (190 slpm) @ 85 psi (5.9 bar) Gouging: 450 scfh, 7.5 scfm (210 slpm) @ 70 psi (4.8 bar)		

- ¹ Defined as a plot of output voltage versus output current.
- ² Equipment complies with IEC 61000-3-12 provided that the short-circuit power S_{sc} is greater than or equal to 2035 KVA at the interface point between the user's supply and the public system. It is the responsibility of the installer or user of the equipment to ensure, by consultation with the distribution network operator if necessary, that the equipment is connected only to a supply with a short-circuit power S_{sc} greater than or equal to 2035 KVA.
- ³ Equipment complies with IEC 61000-3-11 provided that the supply impedance, Z_{max} , is 0.201 or less. It is the responsibility of the installer or user of the equipment to ensure, by consultation with the distribution network operator if necessary, that the equipment is connected only to a supply with a impedance of 0.201 or less.
- ⁴ **WARNING:** This Class A equipment is not intended for use in residential locations where the electrical power is provided by the public low-voltage supply system. There may be potential difficulties in ensuring electromagnetic compatibility in those locations, due to conducted as well as radiated disturbances.

SPECIFICATIONS

Powermax85 power supply ratings

Rated open-circuit voltage (U_0) CSA, single-phase, 3-phase CE, 3-phase	CSA CE	305 VDC 270 VDC
Output characteristic ¹	Drooping	
Rated output current (I_2)	25 – 85 A	
Rated output voltage (U_2)	143 VDC	
Duty cycle at 40° C (104° F) (See data plate on power supply for more information on duty cycle.)	CSA CE	60% @ 85 A, 230 – 600 V, 3 PH 60% @ 85 A, 480 V, 1 PH 50% @ 85 A, 240 V, 1 PH 50% @ 85 A 200 – 208 V, 3 PH 40% @ 85 A 200 – 208 V, 1 PH 100% @ 66 A, 230 – 600 V, 1/3 PH 60% @ 85 A, 380/400 V, 3 PH 100% @ 66 A, 380/400 V, 3 PH
Operating temperature	14° to 104° F (-10° to 40° C)	
Storage temperature	-13° to 131° F (-25° to 55° C)	
Power factor 200 – 480 V CSA, 1-phase 200 – 600 V CSA, 3-phase 380/400 V CE, 3-phase	0.99 – 0.96 0.94 – 0.76 0.94	
R_{sce} – Short Circuit Ratio (CE models only)	U_1 – Volts AC rms, 3PH	R_{sce}
	400 VAC	225.7
EMC classification CISPR 11 (CE models only) ⁴	Class A	
Input voltage (U_1)/ Input current (I_1) at rated output (U_2 $I_{2 MAX}$, $I_{1 MAX}$) (See Section 2, <i>Power Supply Setup</i> for more information.)	CSA CE ^{2,3}	200/208/240/480 V, 1 PH, 50/60 Hz 70/68/58/29 A 200/208/240/480/600 V, 3 PH, 50/60 Hz 42/40/35/18/17 A 380/400 V, 3 PH, 50/60 Hz 20.5/19.5 A
Gas type	Air	Nitrogen
Gas quality	Clean, dry, oil-free per ISO 8573-1 Class 1.2.2	99.95% pure
Recommended gas inlet flow rate/pressure	Cutting: 400 scfh , 6.7 scfm (190 slpm) @ 85 psi (5.9 bar) Gouging: 450 scfh, 7.5 scfm (210 slpm) @ 70 psi (4.8 bar)	

- ¹ Defined as a plot of output voltage versus output current.
- ² Equipment complies with IEC 61000-3-12 provided that the short-circuit power S_{sc} is greater than or equal to 2035 KVA at the interface point between the user's supply and the public system. It is the responsibility of the installer or user of the equipment to ensure, by consultation with the distribution network operator if necessary, that the equipment is connected only to a supply with a short-circuit power S_{sc} greater than or equal to 2035 KVA.
- ³ Equipment complies with IEC 61000-3-11 provided that the supply impedance, Z_{max} , is 0.201 or less. It is the responsibility of the installer or user of the equipment to ensure, by consultation with the distribution network operator if necessary, that the equipment is connected only to a supply with a impedance of 0.201 or less.
- ⁴ **WARNING:** This Class A equipment is not intended for use in residential locations where the electrical power is provided by the public low-voltage supply system. There may be potential difficulties in ensuring electromagnetic compatibility in those locations, due to conducted as well as radiated disturbances.

SPECIFICATIONS

H65/H85 75° hand torch dimensions

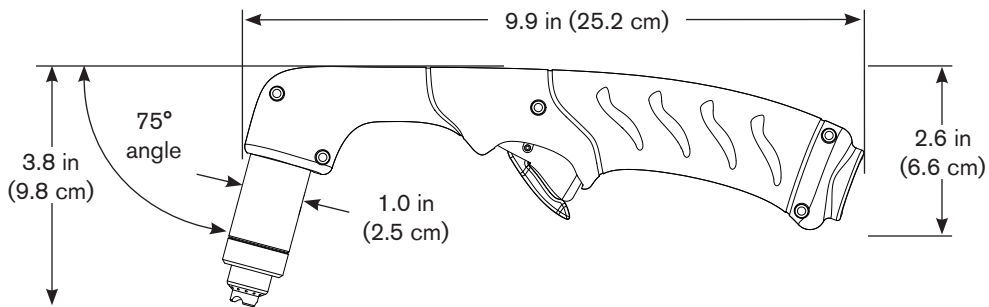

H65s/H85s 15° hand torch dimensions

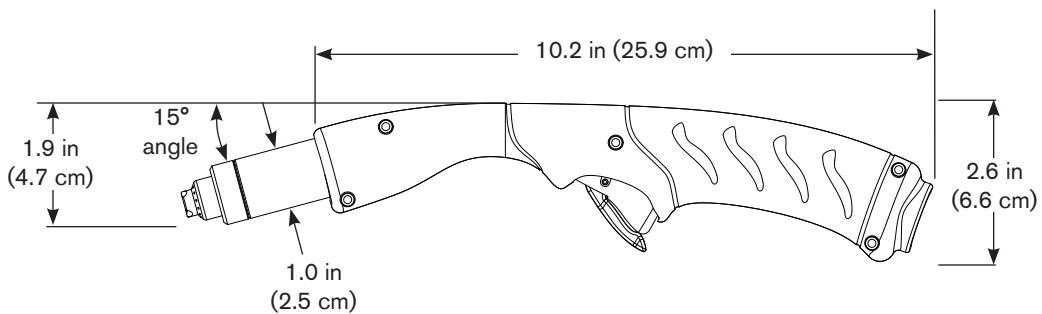

M65/M85 full-length machine torch dimensions

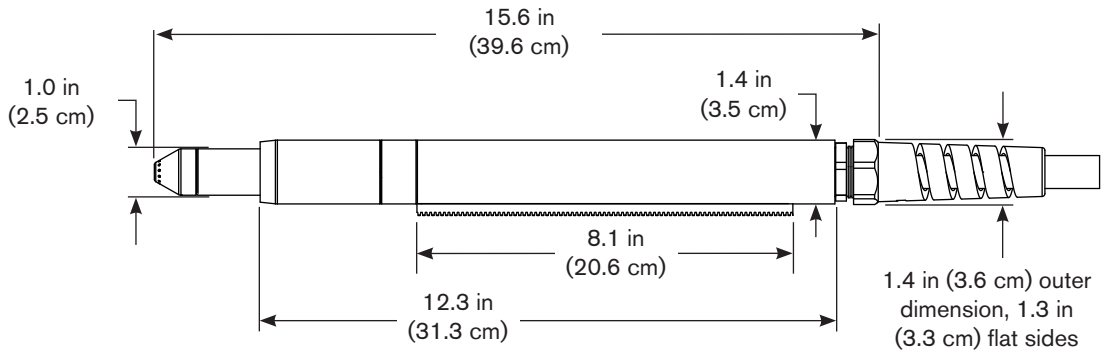

M65m/M85m mini-machine torch dimensions

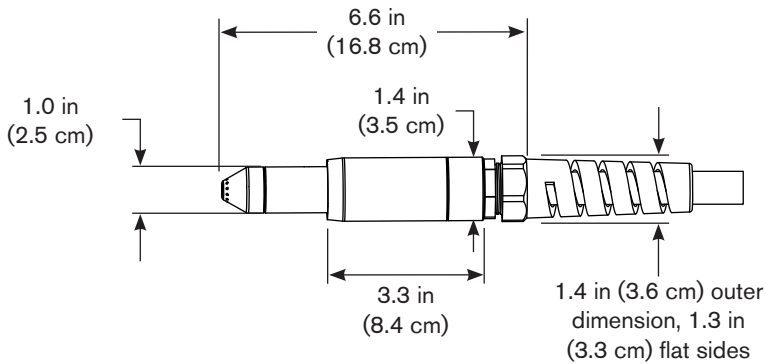

SPECIFICATIONS

Powermax65 cutting specifications

Handheld cut capacity (material thickness)	
Recommended cut capacity at 20 ipm (500 mm/min)	3/4 in (19 mm)
Recommended cut capacity at 10 ipm (250 mm/min)	1 in (25 mm)
Severance capacity at 5 ipm (125 mm/min)	1-1/4 in (32 mm)
Mechanized pierce capacity (material thickness)	
Pierce capacity (for edge starts, the capacities are the same as the handheld capacities)	1/2 in (12 mm)
Maximum cut speed* (mild steel)	
1/4 in (6 mm)	145 ipm (4000 mm/min)
1/2 in (12 mm)	50 ipm (1400 mm/min)
3/4 in (19 mm)	24 ipm (600 mm/min)
1 in (25 mm)	12 ipm (320 mm/min)
Gouging capacity	
Metal removal rate on mild steel	10.7 lbs/hr (4.8 kg/hr)
Duramax series torch weights (refer to “Component weights” on page 1-5)	
Duty cycle and voltage information (refer to “Powermax65 power supply ratings” on page 1-6)	

* Maximum cut speeds are the results of Hypertherm's laboratory testing. Actual cutting speeds may vary based on different cutting applications.

Powermax85 cutting specifications

Handheld cut capacity (material thickness)	
Recommended cut capacity at 20 ipm (500 mm/min)	1 in (25 mm)
Recommended cut capacity at 10 ipm (250 mm/min)	1-1/4 in (32 mm)
Severance capacity at 5 ipm (125 mm/min)	1-1/2 in (38 mm)
Mechanized pierce capacity (material thickness)	
Pierce capacity (for edge starts, the capacities are the same as the handheld capacities)	3/4 in (19 mm)
Maximum cut speed* (mild steel)	
1/4 in (6 mm)	200 ipm (5500 mm/min)
1/2 in (12 mm)	70 ipm (2000 mm/min)
3/4 in (19 mm)	36 ipm (900 mm/min)
1 in (25 mm)	21 ipm (550 mm/min)
1-1/4 in (32 mm)	13 ipm (330 mm/min)
Gouging capacity	
Metal removal rate on mild steel	19.5 lbs/hr (8.8 kg/hr)
Duramax series torch weights (refer to “Component weights” on page 1-5)	
Duty cycle and voltage information (refer to “Powermax85 power supply ratings” on page 1-8)	

* Maximum cut speeds are the results of Hypertherm’s laboratory testing. Actual cutting speeds may vary based on different cutting applications.

Symbols and markings

Your Hypertherm product may have one or more of the following markings on or near the data plate. Due to differences and conflicts in national regulations, not all marks are applied to every version of a product.



S mark symbol

The S mark symbol indicates that the power supply and torch are suitable for operations carried out in environments with increased hazard of electrical shock per IEC 60974-1.



CSA mark

Hypertherm products with a CSA mark meet the United States and Canadian regulations for product safety. The products were evaluated, tested, and certified by CSA-International. Alternatively the product may have a mark by one of the other Nationally Recognized Testing Laboratories (NRTL) accredited in both the United States and Canada, such as Underwriters Laboratories, Incorporated (UL) or TÜV.



CE marking

The CE marking signifies the manufacturer's declaration of conformity to applicable European directives and standards. Only those versions of Hypertherm products with a CE marking located on or near the data plate have been tested for compliance with the European Low Voltage Directive and the European Electromagnetic Compatibility (EMC) Directive. EMC filters needed to comply with the European EMC Directive are incorporated within versions of the product with a CE marking.



GOST-R mark

CE versions of Hypertherm products that include a GOST-R mark of conformity meet the product safety and EMC requirements for export to the Russian Federation.



c-Tick mark

CE versions of Hypertherm products with a c-Tick mark comply with the EMC regulations required for sale in Australia and New Zealand.





















CCC mark

The China Compulsory Certification (CCC) mark indicates that the product has been tested and found compliant with product safety regulations required for sale in China.

IEC symbols

The following symbols may appear on the power supply data plate, control labels, switches, LEDs, and LCD screen.

	Direct current (DC)		Power is ON
	Alternating current (AC)		Power is OFF
	Plasma torch cutting		An inverter-based power source, either 1-phase or 3-phase
	Plate metal cutting		
	Expanded metal cutting		Volt/amp curve, "drooping" characteristic
	Gouging		Power is ON (LED)
	AC input power connection		System fault (LED)
	The terminal for the external protective (earth) conductor		Inlet gas pressure fault (LCD)
			Missing or loose consumables (LCD)
			Power supply is out of temperature range (LCD)

SPECIFICATIONS

Section 2

POWER SUPPLY SETUP

In this section:

Unpack the Powermax65 or Powermax85 system	2-2
Claims	2-2
Contents.....	2-3
Position the power supply.....	2-4
Prepare the electrical power	2-4
Install a line-disconnect switch	2-5
Requirements for grounding	2-5
Power connection for the Powermax65	2-6
Single-phase power cord (not for CE model).....	2-7
Three-phase power cord — plug installation.....	2-7
Power connection for the Powermax85	2-8
Single-phase power cord (not for CE model).....	2-9
Single-phase power cord installation	2-10
Three-phase power cord — plug installation.....	2-11
Extension cord recommendations.....	2-11
Extension cord specifications.....	2-12
Engine-driven generator recommendations	2-13
Prepare the gas supply.....	2-14
Additional gas filtration.....	2-14
Connect the gas supply.....	2-15

Unpack the Powermax65 or Powermax85 system

1. Verify that all items on your order have been received in good condition. Contact your distributor if any parts are damaged or missing.
2. Inspect the power supply for damage that may have occurred during shipping. If there is evidence of damage, refer to “Claims” below. All communications regarding this equipment must include the model number and the serial number located on the back of the power supply.
3. Before you set up and operate this Hypertherm system, read the separate *Safety and Compliance Manual* included with your system for important safety information.

Claims

- **Claims for damage during shipment** – If your unit was damaged during shipment, you must file a claim with the carrier. Hypertherm will furnish you with a copy of the bill of lading upon request. If you need additional assistance, call the nearest Hypertherm office listed in the front of this manual.
- **Claims for defective or missing merchandise** – If any component is missing or defective, contact your Hypertherm distributor. If you need additional assistance, call the nearest Hypertherm office listed in the front of this manual.

Contents

Verify the items in the box against the illustration.

Operator Manual 

Quick Setup Card 

Registration Card 

Setup DVD 

Safety Manual 

Remote-start pendant (optional) 

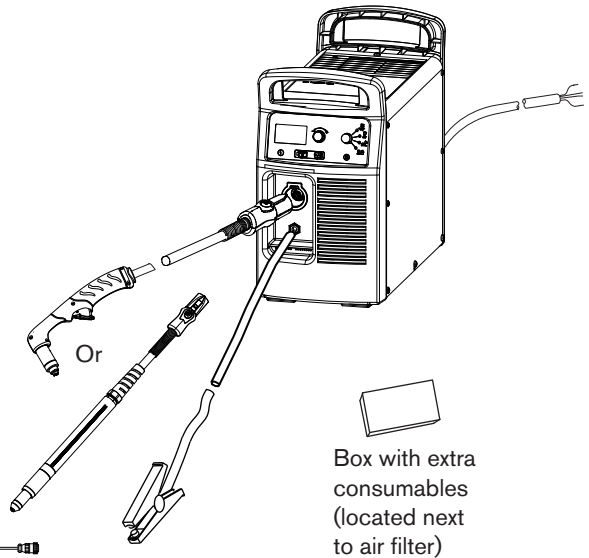

Box with extra consumables (located next to air filter)

POWER SUPPLY SETUP

Position the power supply

Locate the power supply near an appropriate 200–480 volt power receptacle for CSA 1-phase power supplies, 200–600 volt power receptacle for CSA 3-phase power supplies, or a 380/400 volt receptacle for 3-phase CE power supplies. The power supply has a 10-foot (3 m) power cord. Allow at least 10 inches (0.25 m) of space around the power supply for proper ventilation.

The power supply is not suitable for use in rain or snow.

To avoid toppling, do not set the power supply on an incline greater than 10 degrees.

Prepare the electrical power

Hypertherm (designated HYP on the data plate) input current ratings are used to determine conductor sizes for power connection and installation instructions. The HYP rating is determined under maximum normal operating conditions and the higher HYP input current value should be used for installation purposes.

The maximum output voltage will vary based on your input voltage and the circuit's amperage. Because the current draw varies during startup, slow-blow fuses are recommended as shown in the charts below. Slow-blow fuses can withstand currents up to 10 times the rated value for short periods of time.



Caution: Protect the circuit with appropriately sized time-delay (slow-blow) fuses and a line-disconnect switch.

Install a line-disconnect switch

Use a line-disconnect switch for each power supply so that the operator can turn off the incoming power quickly in an emergency. Locate the switch so that it is easily accessible to the operator. Installation must be performed by a licensed electrician according to national and local codes. The interrupt level of the switch must equal or exceed the continuous rating of the fuses. In addition, the switch should:

- Isolate the electrical equipment and disconnect all live conductors from the incoming supply voltage when in the OFF position.
- Have one OFF and one ON position that are clearly marked with O (OFF) and I (ON).
- Have an external operating handle that can be locked in the OFF position.
- Contain a power-operated mechanism that serves as an emergency stop.
- Have appropriate slow-blow fuses installed. See “Power connection for the Powermax65” on page 2-6 or “Power connection for the Powermax85” on page 2-8 for recommended fuse sizes.

Requirements for grounding

To ensure personal safety, proper operation, and to reduce electromagnetic interference (EMI), the power supply must be properly grounded.

- The power supply must be grounded through the power cord according to national and local electrical codes.
- Single-phase service must be of the 3-wire type with a green or green/yellow wire for the protective earth ground and must comply with national and local requirements. **Do not use a 2-wire service.**
- Three-phase service must be of the 4-wire type with a green or green/yellow wire for protective earth ground and must comply with national and local requirements.
- Refer to the separate *Safety and Compliance Manual* included with your system for more information on grounding.

Power connection for the Powermax65

The Powermax65 CSA model is a universal power supply that can configure itself to operate with AC voltages from 200 to 600, 1- or 3-phase. The CE model is 380/400 V, 3-phase only. The rated output is 25 – 65 A, 139 VDC.

CSA model	Single-phase			Three-phase				
	200-208	230-240	480	200-208	230-240	400	480	600
Input voltage	200-208	230-240	480	200-208	230-240	400	480	600
Input current at 9.0 kw output	52	44	22	32	27	15	13	13
Input current during arc stretch	74	74	38	45	45	27	23	23
Fuse (slow-blow)	80	80	40	50	50	30	25	25

CE model	Three-phase
Input voltage	380/400
Input current at 9.0 kw output	15.5/15
Input current during arc stretch	27
Fuse (slow-blow)	30

Single-phase power cord (not for CE model)

To operate your Powermax65 on 1-phase power, you will need to install an appropriate power cord. Refer to “Single-phase power cord installation” on page 2-10 for instructions.



Caution: When using the Powermax65 CSA model power supply (CE model is 3-phase only) with a 1-phase power source, replace the supplied power cord with an 8 AWG (10 mm²) 3-wire power cord. The power cord must be connected by a licensed electrician.

Three-phase power cord — plug installation

The Powermax65 power supplies are shipped with an 8 AWG 4-wire power cord on CSA models. A 2.5 mm², 4-wire HAR power cord is provided on CE models. To operate the Powermax65, use a plug that meets national and local electrical codes. The plug must be connected to the power cord by a licensed electrician.

The procedure is similar to installing a single-phase power cord as shown in the section “Single-phase power cord installation” on page 2-10. The figure below shows the additional wire connected to L3.

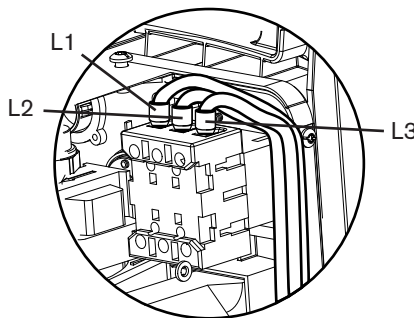

Power connection for the Powermax85

The Powermax85 CSA model is a universal power supply that can configure itself to operate with AC voltages from 200 to 600, 1- or 3-phase. The CE model is 380/400 V, 3-phase only. The rated output is 25 – 85 A, 143 VDC.

CSA model	Single-phase			Three-phase				
	200-208	230-240	480	200-208	230-240	400	480	600
Input voltage	200-208	230-240	480	200-208	230-240	400	480	600
Input current at 12.2 kw output	70	60	29	42	36	21	18	17
Input current during arc stretch	98	98	50	60	60	38	31	30
Fuse (slow-blow)	100	100	50	60	60	40	30	30

CE model	Three-phase
Input voltage	380/400
Input current at 12.2 kw output	20.5/20
Input current during arc stretch	38
Fuse (slow-blow)	40

Single-phase power cord (not for CE model)

To operate your Powermax85 on 1-phase power, you will need to install an appropriate power cord. Refer to “Single-phase power cord installation” on page 2-10 for instructions.



Caution: When using the Powermax85 CSA model power supply (CE model is 3-phase only) with a 1-phase power source, replace the supplied power cord with a 6 AWG (16 mm²) 3-wire power cord. The power cord must be connected by a licensed electrician.

POWER SUPPLY SETUP

Single-phase power cord installation

Strip and prepare the power cord wires as shown below.

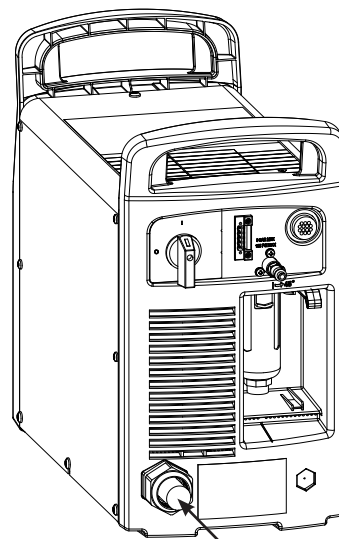
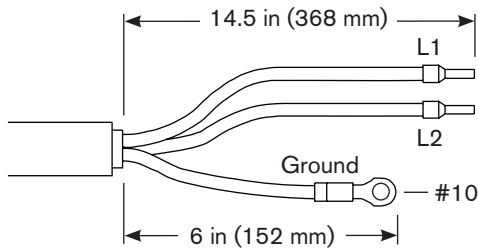

Route lead through strain relief and tighten

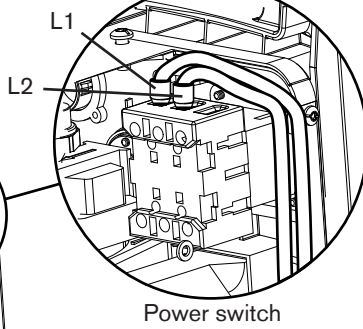
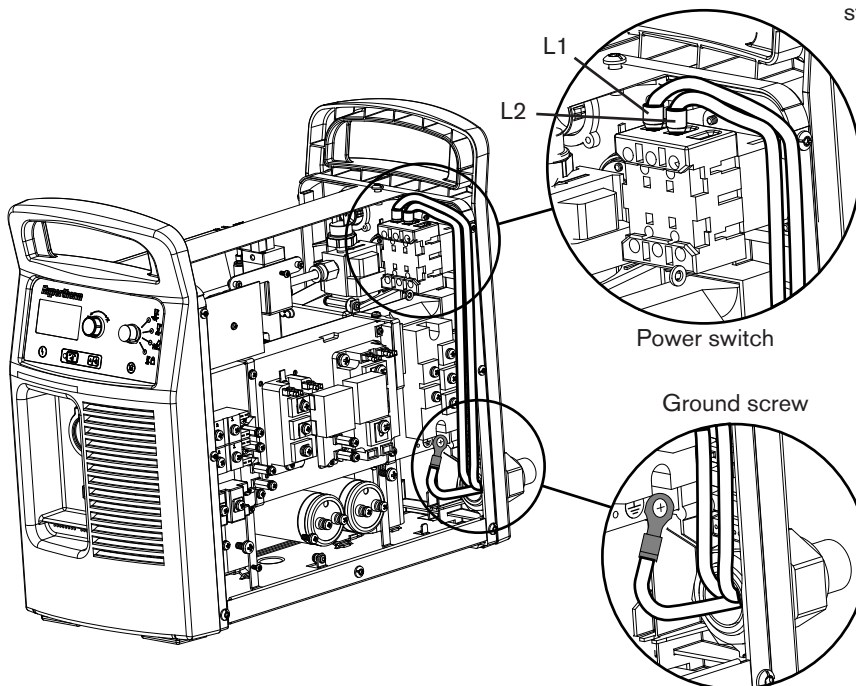

Power switch

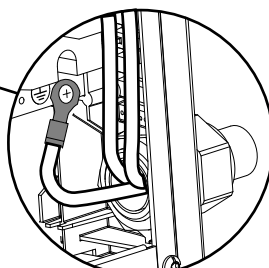

Ground screw

Three-phase power cord — plug installation

The Powermax85 power supplies are shipped with an 8 AWG 4-wire power cord on CSA models. A 4 mm², 4-wire HAR power cord is provided on CE models. To operate the Powermax85, use a plug that meets national and local electrical codes. The plug must be connected to the power cord by a licensed electrician.

The procedure is similar to installing a single-phase power cord as shown in the section “Single-phase power cord installation” on page 2-10. The figure below shows the additional wire connected to L3.

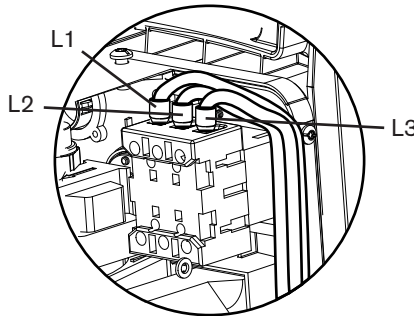

Extension cord recommendations

Any extension cord must have an appropriate wire size for the cord length and system voltage. Use a cord that meets national and local codes.

The table on the next page provides the recommended gauge sizes for various lengths and input voltages. The lengths in the tables are the length of the extension cord only; they do not include the power supply’s power cord.

POWER SUPPLY SETUP

Extension cord specifications

Extension cord length		< 10 ft (< 3 m)	10 – 25 ft (3 – 7.5 m)	25 – 50 ft (7.5 – 15 m)	50 – 100 ft (15 – 30 m)	100 – 150 ft (30 – 45 m)
65 A CSA						
Input voltage (VAC)	Phase	AWG (mm ²)	AWG (mm ²)	AWG (mm ²)	AWG (mm ²)	AWG (mm ²)
200–240	1	8 (10)	8 (10)	8 (10)	6 (16)	4 (25)
480	1	12 (4)	12 (4)	12 (4)	10 (6)	10 (6)
200–240	3	10 (6)	10 (6)	10 (6)	8 (10)	6 (16)
400/480	3	12 (4)	12 (4)	12 (4)	12 (4)	12 (4)
600	3	12 (4)	12 (4)	12 (4)	12 (4)	12 (4)
65 A CE						
Input voltage (VAC)	Phase	mm ²	mm ²	mm ²	mm ²	mm ²
380	3	4	4	4	4	4
400	3	4	4	4	4	4
85 A CSA						
Input voltage (VAC)	Phase	AWG (mm ²)	AWG (mm ²)	AWG (mm ²)	AWG (mm ²)	AWG (mm ²)
200–240	1	6 (16)	6 (16)	6 (16)	4 (25)	2 (35)
480	1	10 (6)	10 (6)	10 (6)	8 (10)	8 (10)
200–240	3	8 (10)	8 (10)	8 (10)	6 (16)	4 (25)
400/480	3	10 (6)	10 (6)	10 (6)	10 (6)	10 (6)
600	3	10 (6)	10 (6)	10 (6)	10 (6)	10 (6)
85 A CE						
Input voltage (VAC)	Phase	mm ²	mm ²	mm ²	mm ²	mm ²
380	3	6	6	6	6	6
400	3	6	6	6	6	6

Engine-driven generator recommendations

Generators used with the Powermax65 or Powermax85 should satisfy the following requirements:

CSA

- 1-phase, 50/60 Hz, 230/240 VAC
- 3-phase, 50/60 Hz, 200-600 VAC (480 VAC recommended for best performance)

CE

- 3-phase, 50/60 Hz, 380/400 VAC (400 VAC recommended for best performance)

Engine drive rating	System output current	Performance (arc stretch)
20 kw	85 A	Full
15 kw	70 A	Limited
15 kw	65 A	Full
12 kw	65 A	Limited
12 kw	40 A	Full
8 kw	40 A	Limited
8 kw	30 A	Full

Note: Based on the generator rating, age, and condition, adjust the cutting current as needed.

If a fault occurs while using a generator, turning the power switch quickly to OFF and then to ON again (sometimes called a “quick reset”) may not clear the fault. Instead, turn OFF the power supply and wait 30 to 45 seconds before turning ON again.

Prepare the gas supply

The gas supply can be shop-compressed or cylinder-compressed. A high-pressure regulator must be used on either type of supply and must be capable of delivering gas to the air inlet on the power supply.

If the supply quality is poor, cut speeds decrease, cut quality deteriorates, cutting thickness capability decreases, and the life of the consumables shortens. For optimal performance, the gas should be compliant with ISO8573-1:2010, Class 1.2.2 (that is, it should have a maximum number of solid particulate per m³ of <20,000 for particle sizes in the range of 0.1-0.5 microns, <400 for particle sizes in the range of 0.5-1 microns, and <10 for particle sizes in the range of 1-5 microns). The maximum water vapor dew point should be <-40° C (-40° F). The maximum oil (aerosol liquid and vapor) content should be less than 0.1 mg/m³.

Additional gas filtration

When site conditions introduce moisture, oil, or other contaminants into the gas line, use a 3-stage coalescing filtration system, such as the Eliminer filter kit (part number 128647) available from Hypertherm distributors. A 3-stage filtering system works as shown below to clean contaminants from the gas supply.

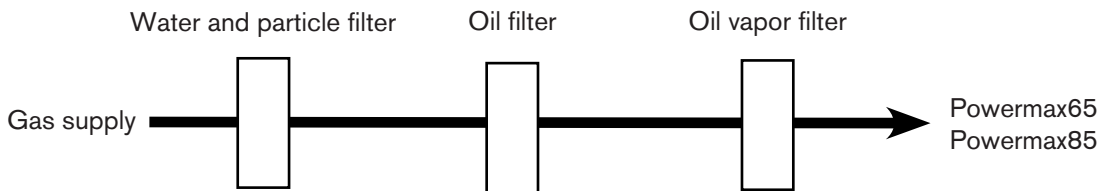

The filtering system should be installed between the gas supply and the power supply. Additional gas filtration may increase the required minimum inlet pressure.

Connect the gas supply

Connect the gas supply to the power supply using an inert-gas hose with a 3/8 inch (9.5 mm) internal diameter and a 1/4 NPT quick-disconnect coupler, or a 1/4 NPT x G-1/4 BSPP (CE units) quick-disconnect coupler.

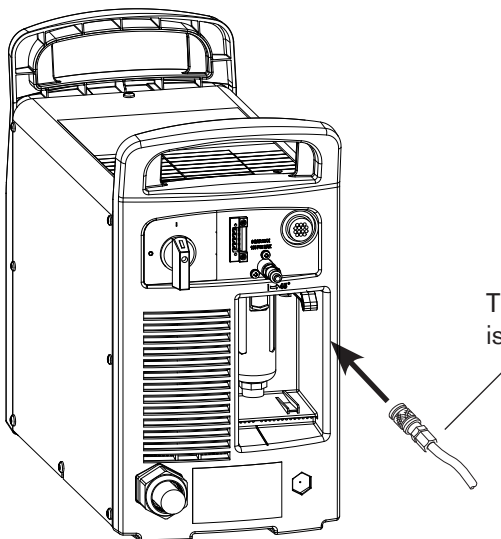

The recommended inlet pressure while gas is flowing is 85 - 135 psi (5.9 - 9.3 bar).



WARNING

Do not allow the gas supply pressure to exceed 135 psi (9.3 bar). The filter bowl may explode if this pressure is exceeded.

POWER SUPPLY SETUP

Minimum inlet pressure (while gas is flowing)

This table shows the minimum required inlet pressure when the recommended inlet pressure is not available.

	Torch lead length		
	25 ft (7.62 m)	50 ft (15.24 m)	75 ft (22.86 m)
Cutting	75 psi (5.2 bar)	80 psi (5.5 bar)	85 psi (5.9 bar)
Gouging	60 psi (4.1 bar)	65 psi (4.5 bar)	70 psi (4.8 bar)

Gas flow rates

Cutting	400 scfh, 6.7 scfm (190 slpm) at a minimum 85 psi (5.9 bar)
Gouging	450 scfh, 7.5 scfm (210 slpm) at a minimum 70 psi (4.8 bar)

Section 3

TORCH SETUP

In this section:

Introduction	3-3
Consumable life.....	3-3
Hand torch setup	3-4
Choose the hand torch consumables	3-5
Hand torch consumables	3-6
Install the hand torch consumables.....	3-7
Machine torch setup.....	3-8
Converting an M65/M85 torch to an M65m/M85m torch	3-9
Mount the torch.....	3-11
Choose the machine torch consumables.....	3-14
Machine torch consumables.....	3-14
Install the machine torch consumables	3-17
Aligning the torch	3-17
Connecting an optional remote-start pendant	3-18
Connecting an optional machine interface cable.....	3-19
Connecting the torch lead.....	3-24

TORCH SETUP

Using the cut charts	3-25
Estimated kerf-width compensation.....	3-26
85 A shielded consumables	3-28
65 A shielded consumables	3-32
45 A shielded consumables	3-36
FineCut® consumables.....	3-40
85 A unshielded consumables.....	3-43
65 A unshielded consumables.....	3-47
45 A unshielded consumables.....	3-51

Introduction

Duramax™ series handheld and machine torches are available for the Powermax65 and Powermax85 systems. The FastConnect™ quick-disconnect system makes it easy to remove the torch for transport or to switch from one torch to the other if your applications require the use of different torches. The torches are cooled by ambient air and do not require special cooling procedures.

This section explains how to set up your torch and choose the appropriate consumables for the job.

Consumable life

How often you need to change the consumables on your Powermax65 or Powermax85 will depend on a number of factors:

- The thickness of the metal being cut.
- The average length of the cut.
- Whether you are doing machine or hand cutting.
- The air quality (presence of oil, moisture, or other contaminants).
- Whether you are piercing the metal or starting cuts from the edge.
- Proper torch-to-work distance when gouging or cutting with unshielded consumables.
- Proper pierce height.
- Whether you are cutting in “continuous pilot arc” mode or normal mode. Cutting with a continuous pilot arc causes more consumable wear.

Under normal conditions, the electrode will wear out first during machine cutting and the nozzle will wear out first when hand cutting.

A general rule is that a set of consumables lasts approximately 2 to 3 hours of actual “arc on” time for hand cutting, depending on these factors. For mechanized cutting, consumables should last about 3 to 5 hours.

You will find more information about proper cutting techniques in Section 4, *Operation*.

TORCH SETUP

Hand torch setup

H65/H85

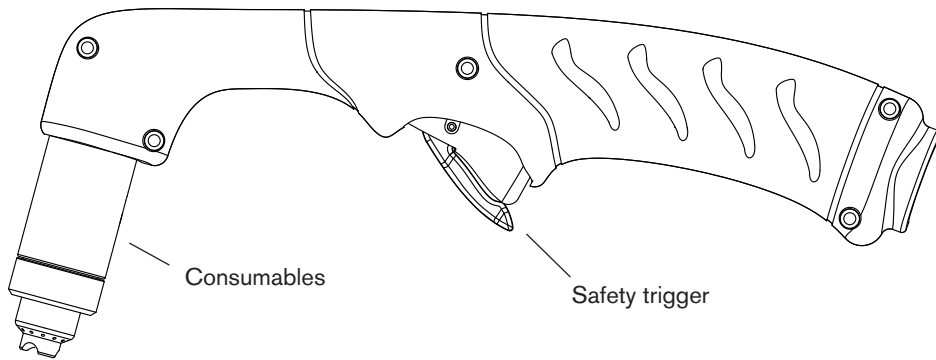

H65s/H85s

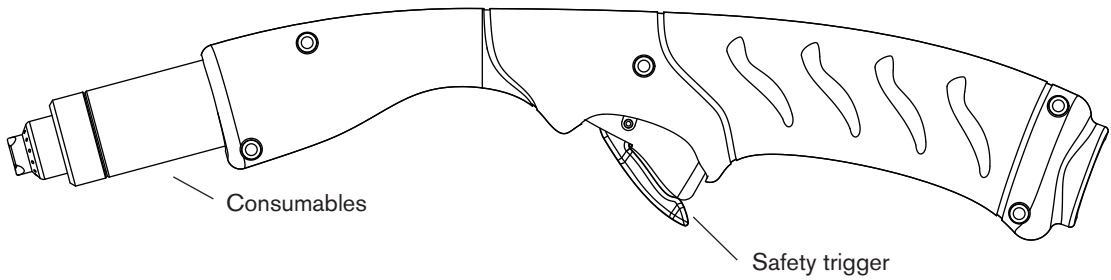

Choose the hand torch consumables

Powermax systems with the Duramax series H65, H85, H65s, or H85s torch are shipped with a full set of cutting consumables pre-installed. Hypertherm also includes spare cutting electrodes and nozzles, and gouging consumables in the consumables box.

Both styles of hand torches shown above use the same consumables.

Hand torches use shielded consumables. Therefore, you can drag the torch tip along the metal.

Consumables for hand cutting are shown on the next page. Notice that the retaining cap and electrode are the same for cutting, gouging, and FineCut® applications. Only the shield, nozzle, and swirl ring are different.

For the best cut quality on thin materials, you may prefer to use FineCut consumables, or use a 45 A nozzle and reduce the amperage to that setting.

TORCH SETUP

Hand torch consumables

Drag-cutting consumables: Powermax65

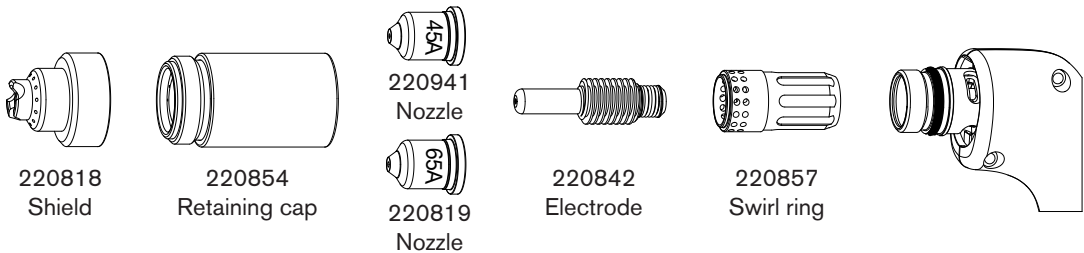

Drag-cutting consumables: Powermax85

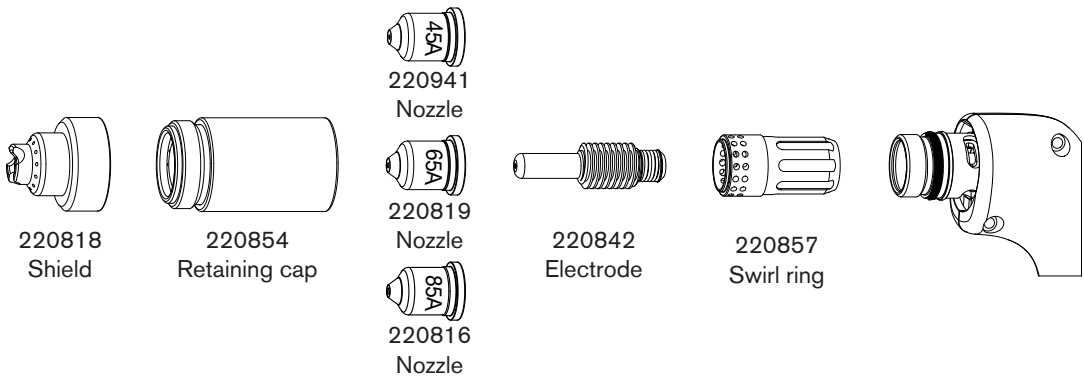

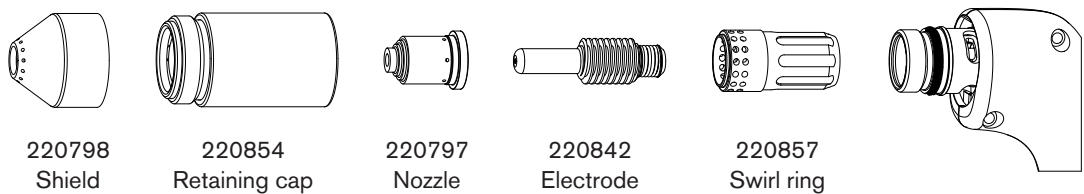

Gouging consumables

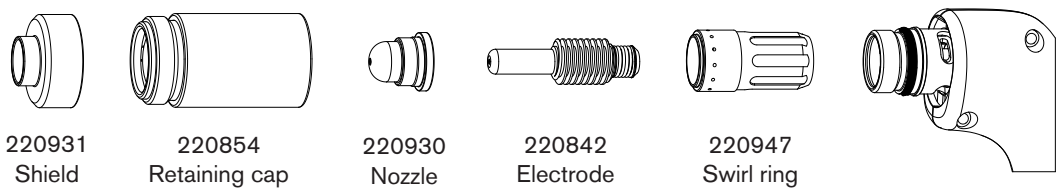

FineCut® consumables

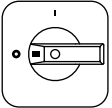

Install the hand torch consumables

		<p>WARNING: INSTANT-ON TORCHES PLASMA ARC CAN CAUSE INJURY AND BURNS</p>
	<p>The plasma arc comes on immediately when the torch trigger is activated. Make sure the power is OFF before changing consumables.</p>	

To operate the hand torch, a complete set of consumable parts must be installed: shield, retaining cap, nozzle, electrode, and swirl ring.

With the power switch in the OFF (O) position, install the torch consumables as shown below.

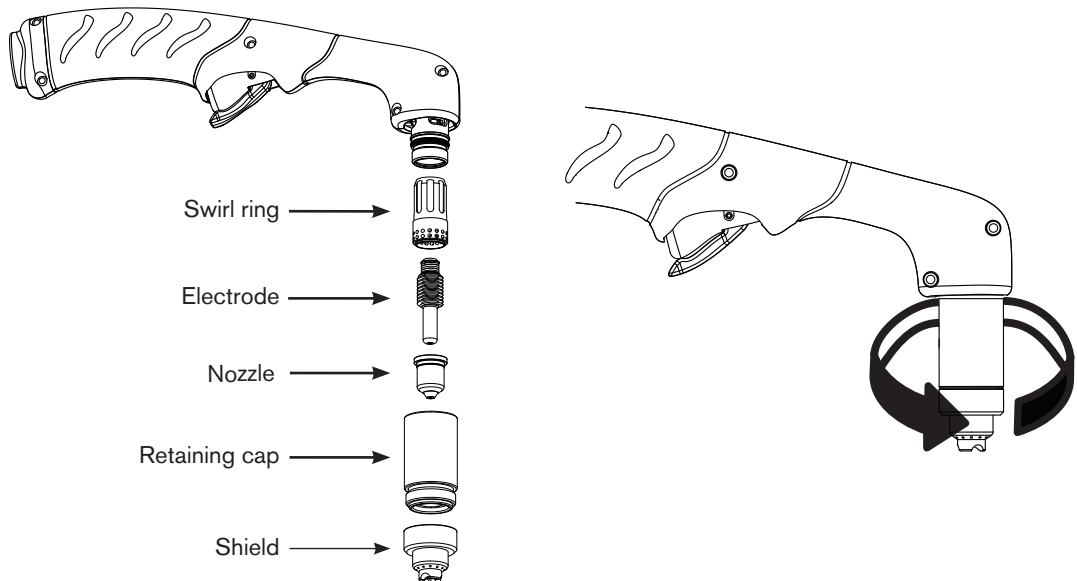

Machine torch setup

M65/M85

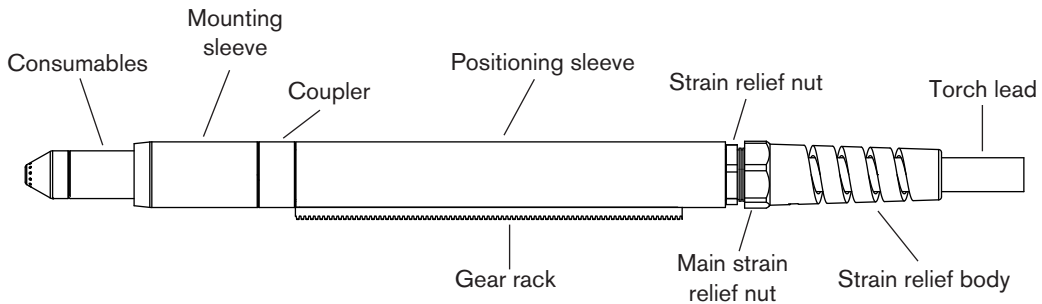

M65m/M85m

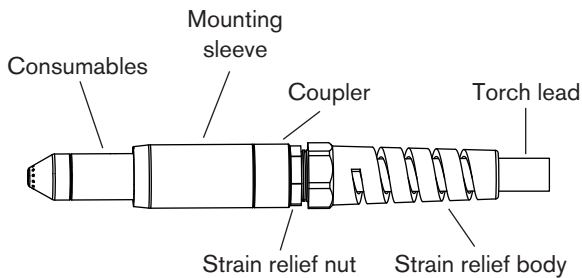

Before using either style of machine torch, you must:

- Mount the torch on your cutting table or other equipment.
- Choose and install the consumables.
- Align the torch.
- Attach the torch lead to the power supply.
- Set up the power supply for remote starting with either the remote-start pendant or a machine interface cable.

Converting an M65/M85 torch to an M65m/M85m torch

You can convert a full-length machine torch to a mini-machine torch by removing the positioning sleeve.

Note: If you are converting a full-length machine torch to a mini-machine torch *and* mounting the torch at the same time, skip this section and follow the instructions in “Mount the torch” on page 3-11.

Refer to the figures in the section “Machine torch setup” on page 3-8 and follow these instructions.

Note: While disconnecting and reconnecting the torch parts, maintain the same orientation between the torch head and torch lead. Twisting the torch head in relation to the torch lead can cause damage.

1. Disconnect the torch lead from the power supply and remove the consumables from the torch.
2. Unscrew the strain relief body from the strain relief nut and slide the strain relief body back along the torch lead.
3. Unscrew the strain relief nut from the positioning sleeve and slide the nut back along the torch lead.
4. Unscrew the positioning sleeve from the coupler.
5. Unscrew the coupler from the mounting sleeve.
6. Remove the three screws from the consumables end of the mounting sleeve and slide the mounting sleeve off the front of the torch body.

TORCH SETUP

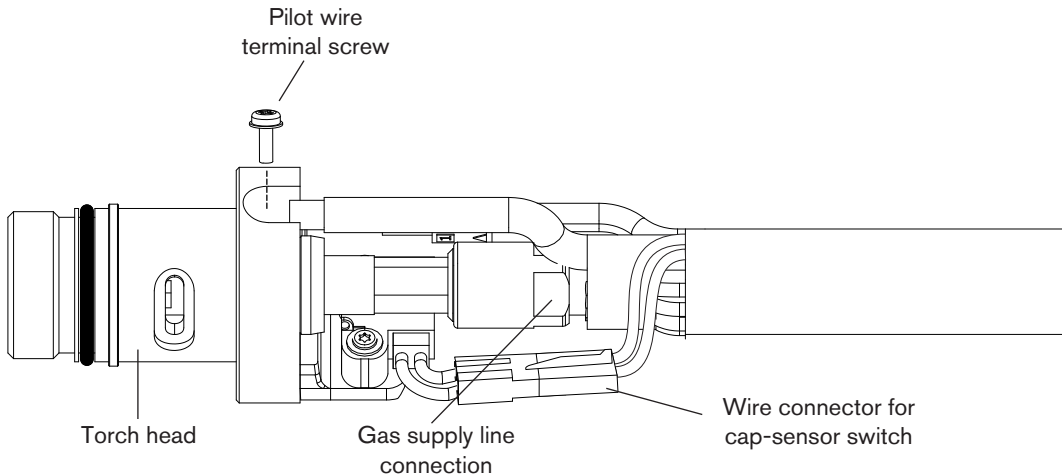

7. Disconnect the wire connector for the cap-sensor switch.
8. Use a #2 Phillips screwdriver to remove the screw that secures the torch's pilot wire to the torch body.
9. Use 1/4-inch and 3/8-inch wrenches, or adjustable wrenches, to loosen the nut that secures the gas supply line to the torch lead. Set the torch body aside.
10. Slide the coupler and positioning sleeve off the front of the torch lead.
11. Slide the coupler over the torch lead.
12. Reconnect the gas line to the torch lead.
13. Reattach the torch's pilot wire to the torch body using the screw.
14. Reconnect the cap-sensor switch's wire connector.
15. Slide the mounting sleeve over the front of the torch body. Align the slot on the front of the mounting sleeve (next to one of the three screw holes) with the cap-sensor plunger on the torch body.
16. Attach the mounting sleeve to the torch body using the three screws.
17. Screw the coupler into the mounting sleeve.
18. Screw the strain relief nut into the coupler.
19. Screw the strain relief body into the strain relief nut.

Mount the torch

Depending on the type of cutting table you have, you may or may not need to disassemble the torch to route it through the track and mount it. If your cutting table's track is large enough for you to thread the torch through it without removing the torch body from the lead, do so and then attach the torch to the lifter per the manufacturer's instructions.

Note: The Duramax machine torches can be mounted on a wide variety of X-Y tables, track burners, pipe bevelers, and other equipment. Install the torch per the manufacturer's instructions and follow the instructions below for disassembly if necessary.

If you need to disassemble and reassemble the torch, refer to the figures in the section "Machine torch setup" on page 3-8 and follow these instructions.

Note: While disconnecting and reconnecting the torch parts, maintain the same orientation between the torch head and torch lead. Twisting the torch head in relation to the torch lead can cause damage.

1. Disconnect the torch lead from the power supply and remove the consumables from the torch.
2. Unscrew the strain relief body from the strain relief nut and slide the strain relief body back along the torch lead.
3. Unscrew the strain relief nut from the positioning sleeve (full-length machine torch) and slide the nut back along the torch lead.
4. Unscrew the positioning sleeve from the coupler.
5. Unscrew the coupler from the mounting sleeve.
6. Remove the three screws from the consumables end of the mounting sleeve and slide the mounting sleeve off the front of the torch body.

TORCH SETUP

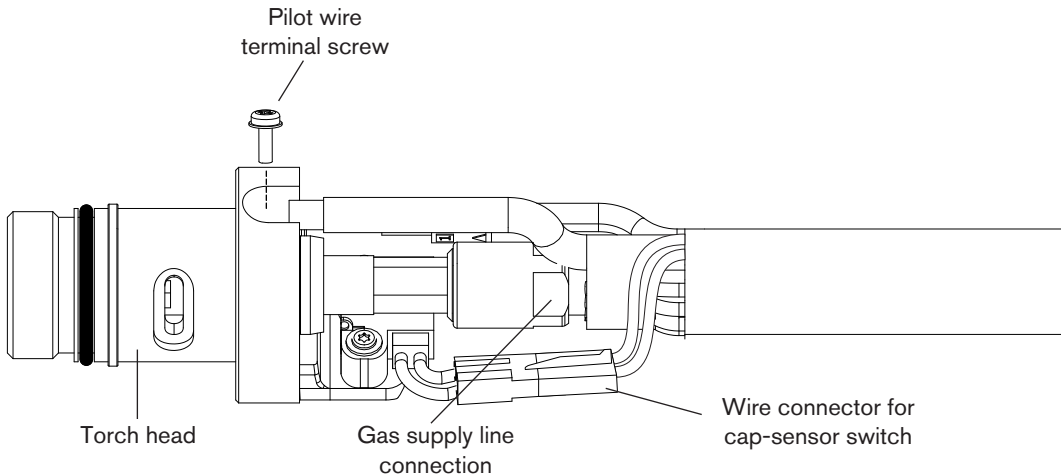

7. Disconnect the wire connector for the cap-sensor switch.
8. Use a #2 Phillips screwdriver to remove the screw that secures the torch's pilot wire to the torch body.
9. Use 1/4-inch and 3/8-inch wrenches, or adjustable wrenches, to loosen the nut that secures the gas supply line to the torch lead. Set the torch body aside.

Note: Cover the end of the gas line on the torch lead with tape to keep dirt and other contaminants from getting in the gas line when you route the lead through the track.

10. Slide the coupler, positioning sleeve (full-length machine torch), strain relief nut, and strain relief body off the front of the torch lead.
11. If you do not need the gear rack on a full-length machine torch, slide the gear rack from the positioning sleeve toward the consumables end of the sleeve.
12. Route the torch lead through the cutting table's track.

13. Slide the strain relief body and strain relief nut over the torch lead.
14. If you are mounting a full-length machine torch, slide the positioning sleeve over the torch head.
15. Slide the coupler over the torch lead.
16. Reconnect the gas line to the torch lead.
17. Reattach the torch's pilot wire to the torch body using the screw.
18. Reconnect the cap-sensor switch's wire connector.
19. Slide the mounting sleeve over the front of the torch body. Align the slot on the front of the mounting sleeve (next to one of the three screw holes) with the cap-sensor plunger on the torch body.
20. Attach the mounting sleeve to the torch body using the three screws.
21. Screw the coupler into the mounting sleeve.
22. If you are mounting a full-length machine torch, screw the positioning sleeve into the coupler.
23. Reconnect the strain relief nut and strain relief body.
24. Attach the torch to the lifter per the manufacturer's instructions.

TORCH SETUP

Choose the machine torch consumables

Powermax systems with the Duramax M65, M85, M65m, or M85m are shipped with a complete set of consumables. Hypertherm also includes spare electrodes and nozzles. In addition, an ohmic-sensing retaining cap is available for use with shielded consumables. With shielded consumables, the torch tip may touch the metal when cutting. With unshielded consumables, you must keep the torch a small distance, about .08 inch (2 mm), away from the metal. Unshielded consumables generally have a shorter life than shielded consumables.

Both styles of machine torches use the same consumables.

Machine torch consumables

Mechanized shielded consumables: Powermax65

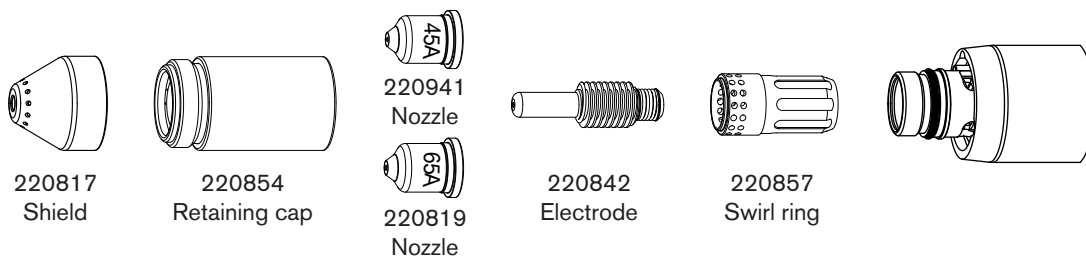

Mechanized shielded with ohmic consumables: Powermax65

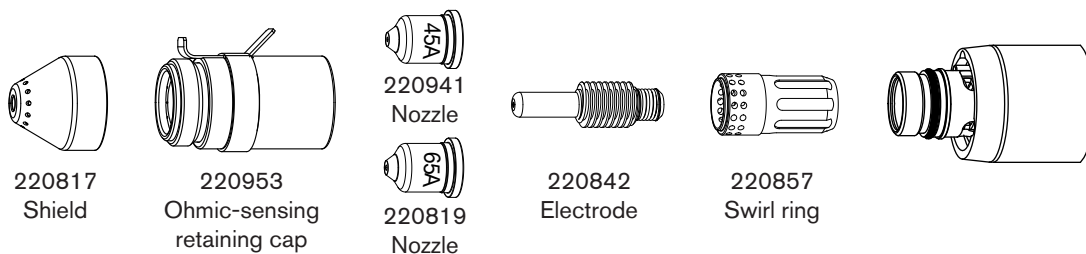

Mechanized unshielded consumables: Powermax65

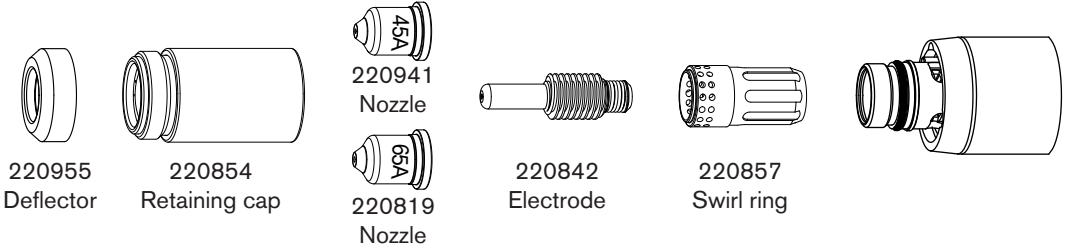

Mechanized shielded consumables: Powermax85

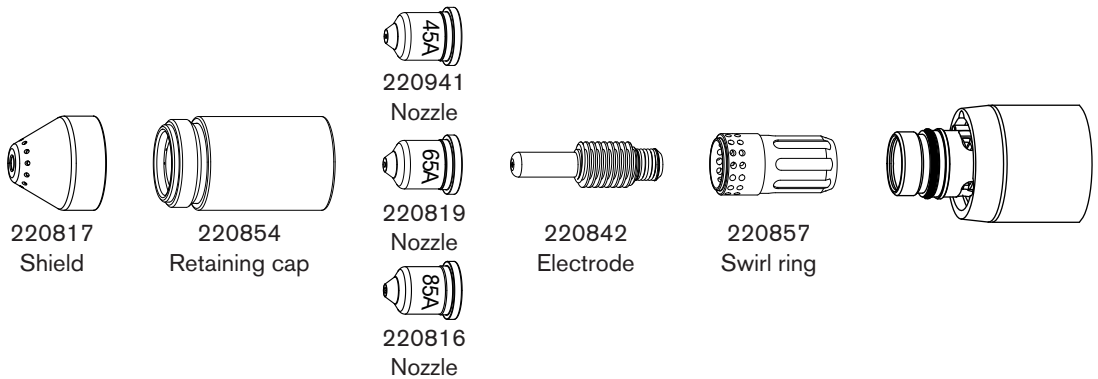

Mechanized shielded with ohmic consumables: Powermax85

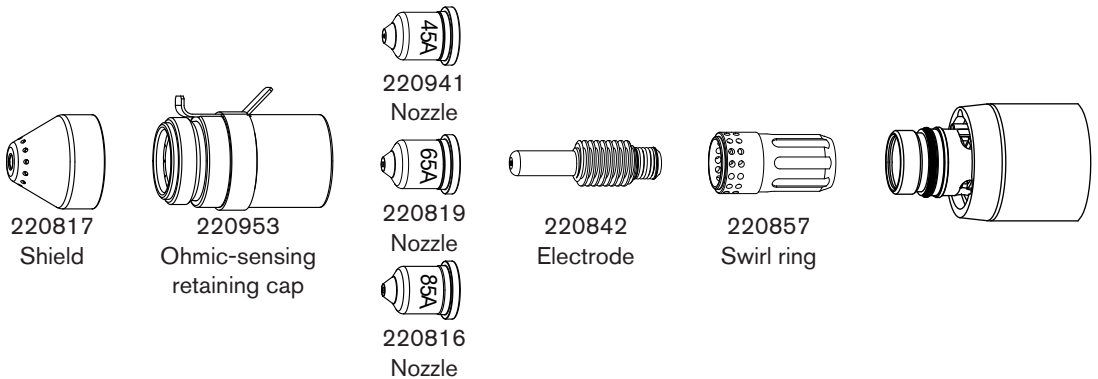

TORCH SETUP

Mechanized unshielded consumables: Powermax85

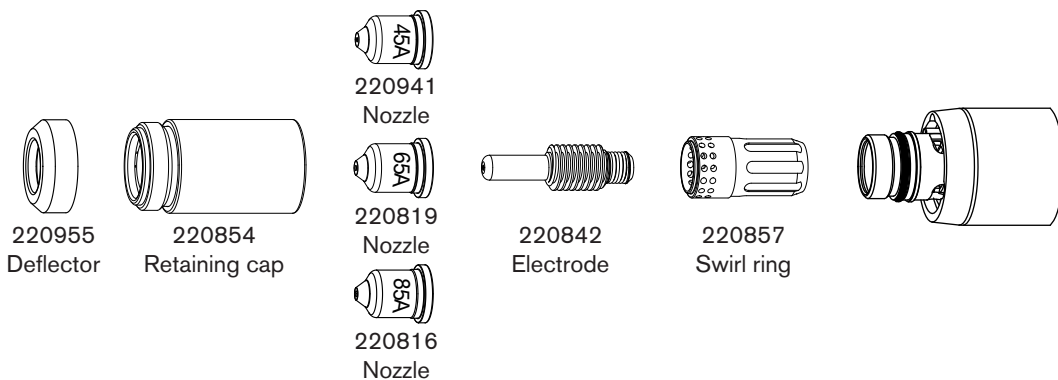

Gouging consumables

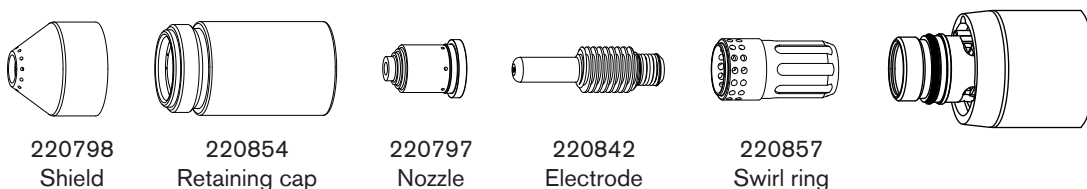

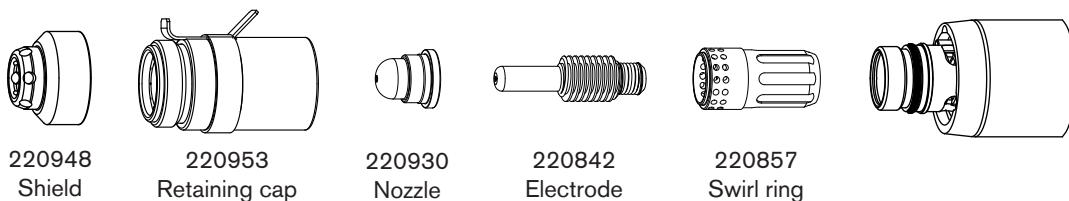

FineCut® shielded consumables

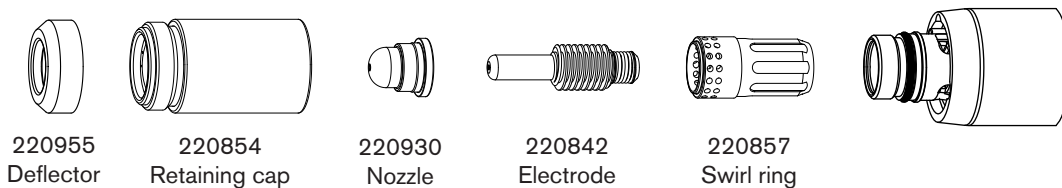

FineCut® unshielded consumables

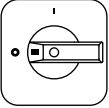

Install the machine torch consumables

		<p>WARNING INSTANT-ON TORCHES PLASMA ARC CAN CAUSE INJURY AND BURNS</p>
	<p>The plasma arc comes on immediately when the torch is activated. Make sure the power is OFF before changing the consumables.</p>	

To operate the machine torch, a complete set of consumable parts must be installed: shield, retaining cap, nozzle, electrode, and swirl ring.

With the power switch in the OFF (O) position, install the machine torch consumables in a manner similar to the hand torch consumables. Refer to “Install the hand torch consumables” on page 3-7.

Aligning the torch

Mount the machine torch perpendicular to the workpiece in order to get a vertical cut. Use a square to align the torch at 0° and 90°.

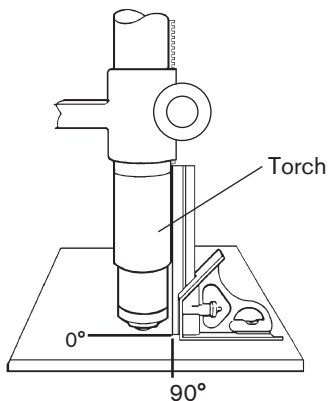

TORCH SETUP

Connecting an optional remote-start pendant

Powermax65 and Powermax85 configurations with a Duramax machine torch can include an optional 25-foot (7.6 m), 50-foot (15 m), or 75-foot (23 m) remote-start pendant. Remove the receptacle cover and plug the Hypertherm remote-start pendant into the receptacle on the rear of the power supply.

Note: The remote-start pendant is for use only with a machine torch. It will not operate if a handheld torch is installed.

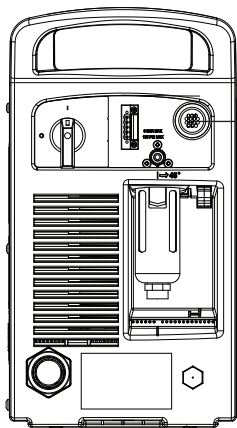

Receptacle for the remote-start pendant or a machine interface cable.

Connecting an optional machine interface cable

The Powermax65 and Powermax85 power supplies are equipped with an optional, factory-installed, five-position voltage divider that is designed to be safely connected without tools. The built-in voltage divider provides a scaled down arc voltage of 20:1, 21.1:1, 30:1, 40:1, and 50:1 (maximum output of 18 V). An optional receptacle on the rear of the power supply provides access to the scaled down arc voltage and signals for arc transfer and plasma start.

Note: The factory presets the voltage divider to 50:1. To change the voltage divider to a different setting, refer to “Setting the five-position voltage divider” on page 3-22.

Caution: The factory-installed internal voltage divider provides a maximum of 18 V under open circuit conditions. This is an impedance-protected functional extra low voltage (ELV) output to prevent shock, energy, and fire under normal conditions at the machine interface receptacle and under single fault conditions with the machine interface wiring. The voltage divider is not fault tolerant and ELV outputs do not comply with safety extra low voltage (SELV) requirements for direct connection to computer products.



Hypertherm offers several choices of machine interface cables for the Powermax65 and Powermax85:

- To use the built-in voltage divider that provides a scaled down arc voltage in addition to signals for arc transfer and plasma start:
 - Use part number 228350 (25 ft, 7.6 m) or 228351 (50 ft, 15 m) for wires terminated with spade connectors.
 - Use part number 123896 (50 ft, 15 m) for a cable terminated with a D-sub connector. (Compatible with Hypertherm’s Edge Ti and Sensor PHC products.)
- To use signals for arc transfer and plasma start only, use either part number 023206 (25 ft, 7.6 m) or part number 023279 (50 ft, 15 m). These cables have spade connectors as shown below.

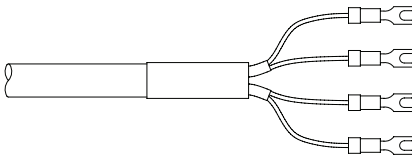

TORCH SETUP

Note: The cover on the machine interface receptacle prevents dust and moisture from damaging the receptacle when not in use. This cover should be replaced if damaged or lost (part number 127204).

See Section 6, *Parts* for more information.

Installation of the machine interface cable must be performed by a qualified service technician. To install a machine interface cable:

1. Turn OFF the power and disconnect the power cord.
2. Remove the machine interface receptacle's cover from the rear of the power supply.
3. Connect the Hypertherm machine interface cable to the power supply.
4. If you are using a cable with a D-sub connector on the other end, plug it into the appropriate pin connector on the torch height controller or CNC. Secure it with the screws on the D-sub connector.

If you are using a cable with wires and spade connectors on the other end, terminate the machine interface cable inside the electrical enclosure of listed and certified torch height controllers or CNC controllers to prevent unauthorized access to the connections after installation. Verify that the connections are correct and that all live parts are enclosed and protected before operating the equipment.

Note: The integration of Hypertherm equipment and customer-supplied equipment including interconnecting cords and cables, if not listed and certified as a system, is subject to inspection by local authorities at the final installation site.

The connector sockets for each type of signal available through the machine interface cable are shown in the figure below. The table provides details about each signal type.

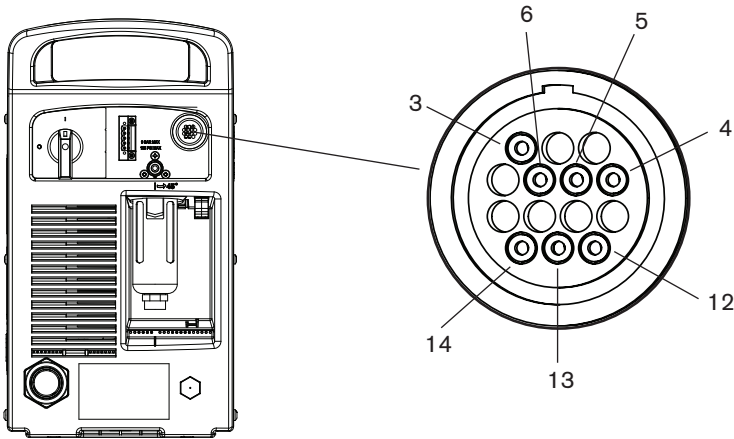

Refer to the following table when connecting the Powermax65 or Powermax85 to a torch height controller or CNC controller with a machine interface cable.

Signal	Type	Notes	Connector sockets	Cable wires
Start (start plasma)	Input	Normally open. 18 VDC open circuit voltage at START terminals. Requires dry contact closure to activate.	3, 4	Green, black
Transfer (start machine motion)	Output	Normally open. Dry contact closure when the arc transfers. 120 VAC/1 A maximum at the machine interface relay or switching device (supplied by the customer).	12, 14	Red, black
Ground	Ground		13	
Voltage divider	Output	Divided arc signal of 20:1, 21.1:1, 30:1, 40:1, 50:1 (provides a maximum of 18 V).	5, 6	Black, white

TORCH SETUP

Setting the five-position voltage divider

To change the factory preset voltage divider from 50:1 to a different setting:

1. Turn OFF the power supply and disconnect the power cord.
2. Remove the power supply cover.
3. Locate the voltage divider DIP switches on the left side of the power supply.

Note: The figure below shows the default setting (50:1) with the number 4 switch up.

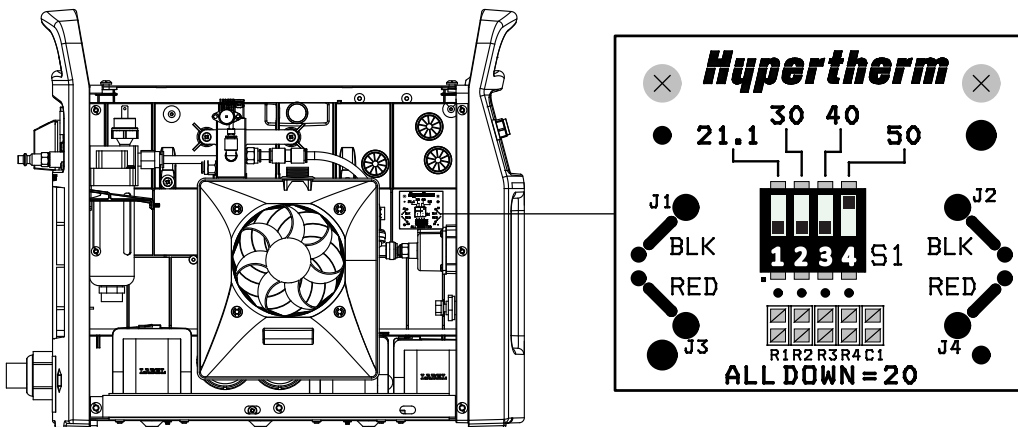

4. Set the DIP switches to one of the following settings and replace the power supply cover.

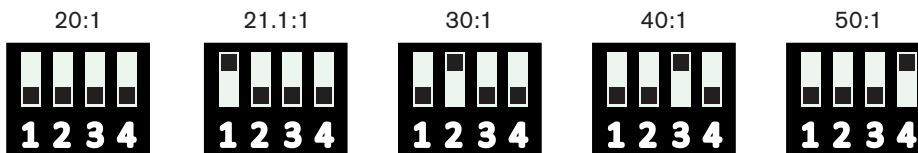

Accessing raw arc voltage

You need to connect a machine interface cable (part number 228350 or 228351) to the power supply in order to access raw arc voltage. Refer to Field Service Bulletin 806180.

**WARNING:
HIGH VOLTAGE AND CURRENT**

Connecting directly to the plasma circuit for access to raw arc voltage increases the risk of shock hazard, energy hazard, and fire hazard in the event of a single fault. The output voltage and the output current of the circuit are specified on the data plate.

TORCH SETUP

Connecting the torch lead

The Powermax65 and Powermax85 are equipped with FastConnect™, a quick-disconnect system for connecting and disconnecting handheld and machine torch leads. When connecting or disconnecting a torch, first turn OFF the system. To connect either torch, push the connector into the receptacle on the front of the power supply.

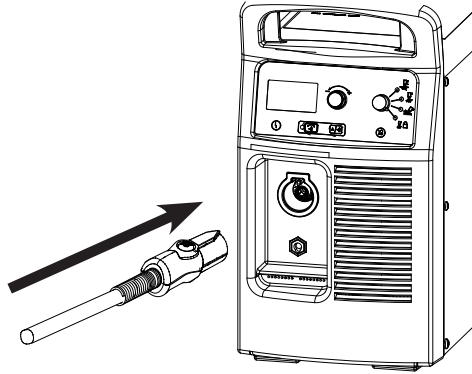

To remove the torch, press the red button on the connector and pull the connector out of the receptacle.

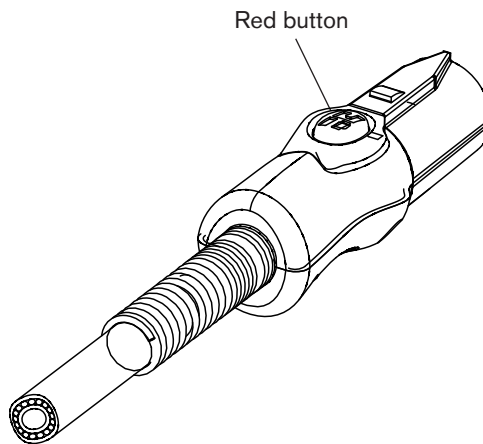

Using the cut charts

The following sections provide cut charts for each set of mechanized consumables. A consumable diagram with part numbers precedes each section.

Maximum cut speeds are the fastest speeds possible to cut material without regard to cut quality. Recommended cut speeds are a good starting point for finding the best quality cut (best angle, least dross, and best cut-surface finish). Adjust the speed for your application and table to obtain the desired cut quality.

Note: Hypertherm collected the data under laboratory test conditions using new consumables.

TORCH SETUP

Estimated kerf-width compensation

The widths in the tables below are for reference. Differences between installations and material composition may cause actual results to vary from those shown in the tables.

Estimated kerf-width compensation - Metric (mm)

Process	Thickness (mm)									
	0.5	1	2	3	6	8	10	12	16	20
	Mild Steel									
85A Shielded				1.7	1.8	1.9	2.0	2.2	2.4	2.6
65A Shielded			1.6	1.6	1.8	1.9	2.0	2.2	2.3	
45A Shielded	1.1	1.1	1.4	1.5	1.7					
FineCut	0.7	0.7	1.3	1.3						
85A Unshielded			1.7	1.8	1.9	2.0	2.1	2.1	2.3	
65A Unshielded			1.6	1.6	1.7	1.8	1.9	2.0		
45A Unshielded	0.5	0.9	1.3	1.3						
Stainless Steel										
85A Shielded				1.6	1.8	1.9	2.1	2.3	2.4	2.5
65A Shielded			1.4	1.5	1.8	1.9	2.0	2.2	2.4	
45A Shielded	0.9	1.1	1.5	1.6	1.8					
FineCut	0.6	0.6	1.4	1.5						
85A Unshielded			1.7	1.7	1.8	1.9	2.1	2.2	2.4	
65A Unshielded			1.6	1.6	1.8	1.8	1.9	2.0		
45A Unshielded	0.5	1.0	1.3	1.5	1.5					
Aluminum										
85A Shielded				2.0	1.9	2.0	2.1	2.2	2.4	2.6
65A Shielded			1.9	1.9	1.9	2.0	2.1	2.3	2.5	
45A Shielded		1.5	1.5	1.6	1.5					
85A Unshielded			1.9	1.9	1.9	2.0	2.0	2.1	2.2	
65A Unshielded			1.8	1.8	1.8	1.8	1.9	2.0		
45A Unshielded		1.6	1.5	1.4	1.5					

Estimated kerf-width compensation - English (inches)

Process	Thickness (inches)									
	22GA	18GA	14GA	10GA	3/16	1/4	3/8	1/2	5/8	3/4
Mild Steel										
85A Shielded				0.068	0.071	0.073	0.078	0.090	0.095	0.100
65A Shielded			0.062	0.065	0.068	0.070	0.076	0.088	0.090	0.091
45A Shielded	0.035	0.054	0.055	0.061	0.065	0.066				
FineCut	0.024	0.043	0.049	0.051						
85A Unshielded				0.070	0.073	0.075	0.080	0.085	0.090	
65A Unshielded			0.062	0.064	0.066	0.068	0.075	0.081		
45A Unshielded	0.020	0.050	0.051	0.054	0.057	0.059				
Stainless Steel										
85A Shielded				0.068	0.071	0.073	0.078	0.090	0.095	0.100
65A Shielded			0.062	0.065	0.068	0.070	0.076	0.088	0.090	0.091
45A Shielded	0.035	0.054	0.055	0.061	0.065	0.066				
FineCut	0.024	0.043	0.049	0.051						
85A Unshielded				0.070	0.073	0.075	0.080	0.085	0.090	
65A Unshielded			0.062	0.064	0.066	0.068	0.075	0.081		
45A Unshielded	0.020	0.050	0.051	0.054	0.057	0.059				
Aluminum										
		1/32	1/16	1/8	3/16	1/4	3/8	1/2	5/8	3/4
85A Shielded				0.080	0.078	0.075	0.080	0.090	0.095	0.100
65A Shielded			0.073	0.074	0.075	0.076	0.083	0.091	0.100	
45A Shielded		0.059	0.061	0.065		0.060				
85A Unshielded				0.075	0.075	0.075	0.080	0.082	0.088	
65A Unshielded			0.070	0.070	0.070	0.070	0.072	0.079		
45A Unshielded		0.062	0.058	0.057		0.061				

TORCH SETUP

85 A shielded consumables

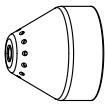

220817
Shield

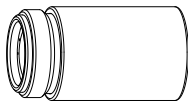

220854
Retaining cap



220816
Nozzle

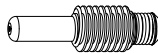

220842
Electrode

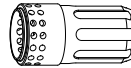

220857
Swirl ring

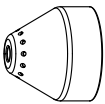
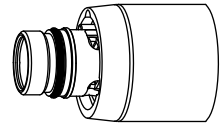

220817
Shield

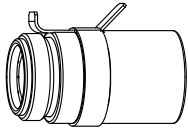

220953
Ohmic-sensing
retaining cap



220816
Nozzle

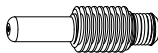

220842
Electrode

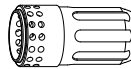

220857
Swirl ring

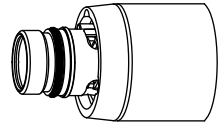

**85A Shielded
Mild Steel**

Air flow rate - slpm/scfh	
Hot	190 / 400
Cold	235 / 500

Metric

Material Thickness	Torch-to-Work Distance	Initial Pierce Height		Pierce Delay Time	Recommended		Maximum		
					Cut Speed	Voltage	Cut Speed	Voltage	
mm	mm	mm	%	seconds	(mm/min)	Volts	(mm/min)	Volts	
3	1.5	3.8	250	0.1	6800	122	11500	115	
4				0.2	5650	122	9100	119	
6				0.5	3600	123	5500	126	
8					2500	125	3900	129	
10					1680	127	2600	129	
12		4.5	300	0.7	1280	130	2000	130	
16				1.0	870	134	1150	132	
20				1.5	570	137	850	135	
25		Edge Start				350	142	550	139
30		Edge Start				200	146	370	143

English

Material Thickness	Torch-to-Work Distance	Initial Pierce Height		Pierce Delay Time	Recommended		Maximum	
					Cut Speed	Voltage	Cut Speed	Voltage
	in	in	%	seconds	ipm	Volts	ipm	Volts
10GA	0.06	0.15	250	0.0	250	122	420	117
3/16 in				0.2	185	123	275	121
1/4 in				0.5	130	123	200	128
3/8 in					70	126	108	129
1/2 in					45	131	70	130
5/8 in		0.18	300	1.0	35	134	46	132
3/4 in				1.5	24	136	36	134
7/8 in				Edge Start			19	139
1 in		Edge Start			13	142	21	140
1-1/8 in		Edge Start			9	145	16	142
1-1/4 in	Edge Start			7	148	13	145	

TORCH SETUP

85A Shielded
Stainless Steel

Air flow rate - slpm/scfh	
Hot	190 / 400
Cold	235 / 500

Metric

Material Thickness	Torch-to-Work Distance	Initial Pierce Height		Pierce Delay Time	Recommended		Maximum	
					Cut Speed	Voltage	Cut Speed	Voltage
mm	mm	mm	%	seconds	(mm/min)	Volts	(mm/min)	Volts
3	1.5	3.8	250	0.1	7500	122	11500	115
4				0.2	6100	122	9400	117
6				0.5	3700	122	5700	121
8					2450	124	3800	123
10					1550	127	2400	124
12		4.5	300	0.7	1100	131	1750	125
16				1.0	700	135	950	131
20				Edge Start		480	138	700
25		300	143			480	135	

English

Material Thickness	Torch-to-Work Distance	Initial Pierce Height		Pierce Delay Time	Recommended		Maximum		
					Cut Speed	Voltage	Cut Speed	Voltage	
	in	in	%	seconds	ipm	Volts	ipm	Volts	
10GA	0.06	0.15	250	0.2	275	122	420	116	
3/16 in					200	122	300	119	
1/4 in				0.5	130	122	205	122	
3/8 in					65	126	100	124	
1/2 in					36	132	60	125	
5/8 in		0.18	300	1.0	28	135	38	131	
3/4 in				Edge Start		20	137	30	132
7/8 in						16	140	24	134
1 in		11	143			18	135		

**85A Shielded
Aluminum**

Air flow rate - slpm/scfh	
Hot	190 / 400
Cold	235 / 500

Metric

Material Thickness	Torch-to-Work Distance	Initial Pierce Height		Pierce Delay Time	Recommended		Maximum		
					Cut Speed	Voltage	Cut Speed	Voltage	
mm	mm	mm	%	seconds	(mm/min)	Volts	(mm/min)	Volts	
3	1.5	3.8	250	0.1	8000	122	11800	117	
4				0.2	6500	123	10000	118	
6				0.5	3800	126	6100	121	
8					2650	130	4300	123	
10					1920	132	3100	125	
12		4.5	300	0.7	1450	134	2400	127	
16				1.0	950	139	1500	130	
20		Edge Start				600	143	1100	133
25						380	146	670	140

English

Material Thickness	Torch-to-Work Distance	Initial Pierce Height		Pierce Delay Time	Recommended		Maximum	
					Cut Speed	Voltage	Cut Speed	Voltage
	in	in	%	seconds	ipm	Volts	ipm	Volts
1/8 in	0.06	0.15	250	0.2	300	122	450	117
1/4 in				0.5	130	127	215	122
3/8 in					80	132	130	124
1/2 in					50	135	85	128
5/8 in				0.18	300	1.0	38	139
3/4 in		Edge Start				25	142	46
7/8 in					20	144	36	137
1 in					14	146	25	141

TORCH SETUP

65 A shielded consumables

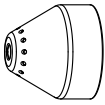

220817
Shield

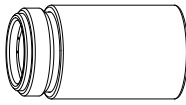

220854
Retaining cap



220819
Nozzle

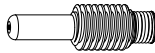

220842
Electrode

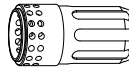

220857
Swirl ring

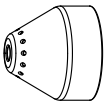
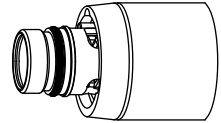

220817
Shield

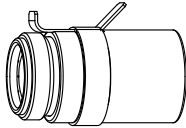

220953
Ohmic-sensing
retaining cap



220819
Nozzle

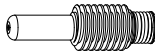

220842
Electrode

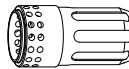

220857
Swirl ring

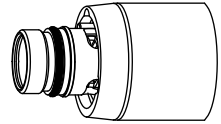

**65A Shielded
Mild Steel**

Air flow rate - slpm/scfh	
Hot	160 / 340
Cold	220 / 470

Metric

Material Thickness	Torch-to-Work Distance	Initial Pierce Height		Pierce Delay Time	Recommended		Maximum	
					Cut Speed	Voltage	Cut Speed	Voltage
mm	mm	mm	%	seconds	(mm/min)	Volts	(mm/min)	Volts
2	1.5	3.8	250	0.1	6050	124	8800	120
3				0.2	5200	125	7600	122
4				0.5	4250	125	6400	123
6					2550	127	4000	129
8				1700	129	2800	130	
10		4.5	300	0.7	1100	131	1900	130
12				1.2	850	134	1400	132
16				2.0	560	138	800	136
20		Edge Start			350	142	560	140
25		Edge Start			210	145	320	143

English

Material Thickness	Torch-to-Work Distance	Initial Pierce Height		Pierce Delay Time	Recommended		Maximum	
					Cut Speed	Voltage	Cut Speed	Voltage
	in	in	%	seconds	ipm	Volts	ipm	Volts
16GA	0.06	0.15	250	0.1	260	123	370	118
10GA					190	125	280	123
3/16 in				0.2	140	126	210	124
1/4 in				0.5	90	127	145	130
3/8 in					0.7	45	130	78
1/2 in		0.18	300	1.2	30	135	50	132
5/8 in				2.0	23	138	32	136
3/4 in				Edge Start			15	141
7/8 in		Edge Start			12	143	18	141
1 in		Edge Start			8	145	12	143

TORCH SETUP

65A Shielded
Stainless Steel

Air flow rate - slpm/scfh	
Hot	160 / 340
Cold	220 / 470

Metric

Material Thickness	Torch-to-Work Distance	Initial Pierce Height		Pierce Delay Time	Recommended		Maximum	
					Cut Speed	Voltage	Cut Speed	Voltage
mm	mm	mm	%	seconds	(mm/min)	Volts	(mm/min)	Volts
2	1.5	3.8	250	0.1	8100	125	12500	122
3				0.2	6700	125	10500	123
4				0.5	5200	125	7700	124
6					2450	126	3600	126
8				0.7	1500	129	2300	127
10		4.5	300		960	132	1550	127
12					1.2	750	135	1150
16		Edge Start			500	139	650	134
20		Edge Start			300	143	450	136

English

Material Thickness	Torch-to-Work Distance	Initial Pierce Height		Pierce Delay Time	Recommended		Maximum		
					Cut Speed	Voltage	Cut Speed	Voltage	
	in	in	%	seconds	ipm	Volts	ipm	Volts	
16GA	0.06	0.15	250	0.1	345	124	530	121	
10GA					240	125	370	123	
3/16 in				0.2	155	126	210	125	
1/4 in					0.5	80	126	120	126
3/8 in						0.18	300	0.7	40
1/2 in		1.2	26	136	40			129	
5/8 in			Edge Start					20	139
3/4 in		Edge Start			14	142	19	136	

**65A Shielded
Aluminum**

Air flow rate - slpm/scfh	
Hot	160 / 340
Cold	220 / 470

Metric

Material Thickness	Torch-to-Work Distance	Initial Pierce Height		Pierce Delay Time	Recommended		Maximum	
					Cut Speed	Voltage	Cut Speed	Voltage
mm	mm	mm	%	seconds	(mm/min)	Volts	(mm/min)	Volts
2	1.5	3.8	250	0.1	8800	121	12800	122
3				0.2	7400	124	11000	123
4				0.5	6000	126	9150	124
6					3200	130	5500	127
8		4.5	300	0.7	1950	133	3450	129
10					1200	136	2050	130
12					1000	138	1650	132
16					Edge Start		650	143
20	380	147	700	137				

English

Material Thickness	Torch-to-Work Distance	Initial Pierce Height		Pierce Delay Time	Recommended		Maximum	
					Cut Speed	Voltage	Cut Speed	Voltage
	in	in	%	seconds	ipm	Volts	ipm	Volts
1/16 in	0.06	0.15	250	0.1	365	121	535	121
1/8 in					280	124	420	123
1/4 in				0.5	105	131	190	127
3/8 in					0.7	50	135	85
1/2 in		1.2	35	139		60	133	
5/8 in			Edge Start		26	143	40	134
3/4 in		16			146	30	136	

TORCH SETUP

45 A shielded consumables

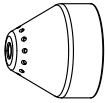

220817
Shield

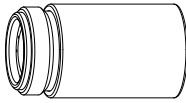

220854
Retaining cap



220941
Nozzle

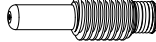

220842
Electrode

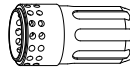

220857
Swirl ring

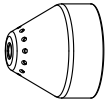
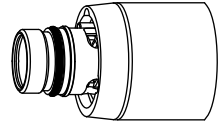

220817
Shield

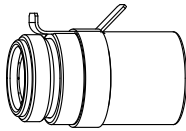

220953
Ohmic-sensing
retaining cap



220941
Nozzle

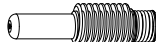

220842
Electrode

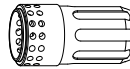

220857
Swirl ring

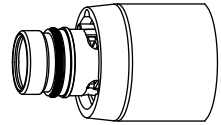

**45A Shielded
Mild Steel**

Air flow rate - slpm/scfh	
Hot	147 / 310
Cold	210/ 450

Metric

Material Thickness	Torch-to-Work Distance	Initial Pierce Height		Pierce Delay Time	Recommended		Maximum	
					Cut Speed	Voltage	Cut Speed	Voltage
mm	mm	mm	%	seconds	(mm/min)	Volts	(mm/min)	Volts
0.5	1.5	3.8	250	0.0	9000	128	12700	128
1					9000	128	12700	128
1.5				0.1	9000	130	12700	128
2					0.3	6600	130	9750
3				0.4		3850	133	6150
4					2200	134	4450	131
6				0.5	1350	137	2550	132

English

Material Thickness	Torch-to-Work Distance	Initial Pierce Height		Pierce Delay Time	Recommended		Maximum	
					Cut Speed	Voltage	Cut Speed	Voltage
	in	in	%	seconds	ipm	Volts	ipm	Volts
26GA	0.06	0.15	250	0.0	350	128	500	128
22GA					350	128	500	128
18GA				0.1	350	129	500	128
16GA					350	130	500	128
14GA				0.2	270	130	400	128
12GA					0.4	190	133	270
10GA				100		134	205	131
3/16 in				0.5	70	135	135	132
1/4 in				0.6	48	137	91	132

TORCH SETUP

45A Shielded
Stainless Steel

Air flow rate - slpm/scfh	
Hot	147 / 310
Cold	210/ 450

Metric

Material Thickness	Torch-to-Work Distance	Initial Pierce Height		Pierce Delay Time	Recommended		Maximum	
					Cut Speed	Voltage	Cut Speed	Voltage
mm	mm	mm	%	seconds	(mm/min)	Volts	(mm/min)	Volts
0.5	1.5	3.8	250	0.0	9000	130	12700	130
1					9000	130	12700	130
1.5				9000	130	12700	130	
2				6000	132	10800	130	
3				0.4	3100	132	5550	131
4					2000	134	3250	132
6				0.5	900	140	1250	138

English

Material Thickness	Torch-to-Work Distance	Initial Pierce Height		Pierce Delay Time	Recommended		Maximum	
					Cut Speed	Voltage	Cut Speed	Voltage
	in	in	%	seconds	ipm	Volts	ipm	Volts
26GA	0.06	0.15	250	0.0	350	130	500	130
22GA					350	130	500	130
18GA				0.1	350	130	500	130
16GA					350	130	500	130
14GA				0.2	250	132	450	130
12GA				0.4	140	132	258	130
10GA					100	133	168	135
3/16 in				0.5	52	135	73	133
1/4 in				0.6	30	141	44	140

**45A Shielded
Aluminum**

Air flow rate - slpm/scfh	
Hot	147 / 310
Cold	210/ 450

Metric

Material Thickness	Torch-to-Work Distance	Initial Pierce Height		Pierce Delay Time	Recommended		Maximum	
					Cut Speed	Voltage	Cut Speed	Voltage
mm	mm	mm	%	seconds	(mm/min)	Volts	(mm/min)	Volts
1	1.5	3.8	250	0.0	8250	136	12700	136
2				0.1	6600	136	11500	133
3				0.2	3100	139	7800	133
4				0.4	2200	141	6050	134
6				0.5	1500	142	3500	136

English

Material Thickness	Torch-to-Work Distance	Initial Pierce Height		Pierce Delay Time	Recommended		Maximum	
					Cut Speed	Voltage	Cut Speed	Voltage
	in	in	%	seconds	ipm	Volts	ipm	Volts
1/32 in	0.06	0.15	250	0.0	325	136	500	137
1/16 in				0.1	325	136	500	135
3/32 in				0.2	200	136	410	132
1/8 in				0.4	100	140	280	133
1/4 in				0.5	54	142	120	136

TORCH SETUP

FineCut® consumables

Note: The cut charts in this section apply to both shielded and unshielded consumables

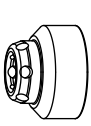

220948
Shield

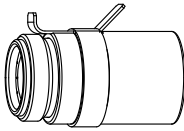

220953
Retaining cap



220930
Nozzle

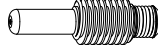

220842
Electrode

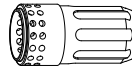

220857
Swirl ring

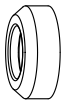
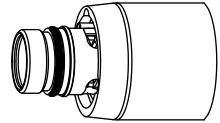

220955
Deflector

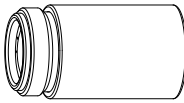

220854
Retaining cap



220930
Nozzle

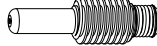

220842
Electrode

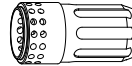

220857
Swirl ring

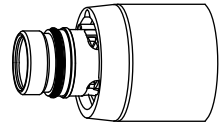

TORCH SETUP

**FineCut
Mild Steel**

Air flow rate - slpm/scfh	
Hot	155 / 330
Cold	215 / 460

Metric

Material Thickness	Amps	Torch-to-Work Distance	Initial Pierce Height		Pierce Delay Time	Recommended		Maximum		
						Cut Speed	Voltage	Cut Speed	Voltage	
mm	A	mm	mm	%	seconds	(mm/min)	Volts	(mm/min)	Volts	
0.5	40	1.5	3.8	250	0	8250	78	12700	80	
0.6						8250	78	12700	81	
0.8						8250	78	12700	80	
1	45				0.1	8250	78	12700	82	
1.5						0.2	6400	78	8500	81
2							5250	82	6250	81
3						0.5	2750	83	3650	81
4							1900	84	2450	81

English

Material Thickness	Amps	Torch-to-Work Distance	Initial Pierce Height		Pierce Delay Time	Recommended		Maximum		
						Cut Speed	Voltage	Cut Speed	Voltage	
	A	in	in	%	seconds	ipm	Volts	ipm	Volts	
26GA	40	0.06	0.15	250	0.0	325	78	500	80	
24GA						325	78	500	81	
22GA					0.1	325	78	500	80	
20GA						325	78	500	82	
18GA	45				0.2	325	78	440	81	
16GA						0.4	250	78	330	81
14GA							220	82	260	81
12GA						0.5	120	83	160	81
10GA		95	84	124			81			

TORCH SETUP

FineCut
Stainless Steel

Air flow rate - slpm/scfh	
Hot	155 / 330
Cold	215 / 460

Metric

Material Thickness	Amps	Torch-to-Work Distance	Initial Pierce Height		Pierce Delay Time	Recommended		Maximum												
						Cut Speed	Voltage	Cut Speed	Voltage											
mm	A	mm	mm	%	seconds	(mm/min)	Volts	(mm/min)	Volts											
0.5	40	0.5	2.0	400	0	8250	68	12700	63											
0.6						8250	68	12700	65											
0.8						8250	68	12700	64											
1	45				0.15	0.15	8250	68	12700	65										
1.5											0.4	6150	70	10650	64					
2																0.5	2550	81	3250	68
3											0.6	1050	84	1250	72					
4																				

English

Material Thickness	Amps	Torch-to-Work Distance	Initial Pierce Height		Pierce Delay Time	Recommended		Maximum										
						Cut Speed	Voltage	Cut Speed	Voltage									
	A	in	in	%	seconds	ipm	Volts	ipm	Volts									
26GA	40	0.02	0.08	400	0.0	325	68	500	68									
24GA						325	68	500	65									
22GA					0.1	325	68	500	64									
20GA						325	68	500	65									
18GA	45				0.2	0.4	0.2	325	68	500	65							
16GA												0.4	240	70	410	64		
14GA																	0.5	200
12GA												0.6	120	80	155	67		
10GA		0.6	75	83														

85 A unshielded consumables

220955
Deflector

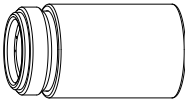

220854
Retaining cap



220816
Nozzle

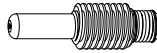

220842
Electrode

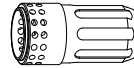

220857
Swirl ring

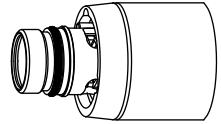

TORCH SETUP

85A Unshielded
Mild Steel

Air flow rate - slpm/scfh	
Hot	190 / 400
Cold	235 / 500

Metric

Material Thickness	Torch-to-Work Distance	Initial Pierce Height		Pierce Delay Time	Recommended		Maximum	
		mm	%		Cut Speed	Voltage	Cut Speed	Voltage
mm	mm	mm	%	seconds	(mm/min)	Volts	(mm/min)	Volts
2	2.0	5.0	250	0.0	7150	117	13000	113
3				0.1	6240	118	11200	114
4				0.2	5250	118	9000	117
6				0.5	3450	120	5500	120
8					2400	121	3900	121
10		1560	123	2600	122			
12		6.0	300	0.7	1200	126	2000	124
16		Edge Start			820	132	1150	126
20		Edge Start			540	137	800	131
25		Edge Start			320	143	500	137

English

Material Thickness	Torch-to-Work Distance	Initial Pierce Height		Pierce Delay Time	Recommended		Maximum	
		in	%		Cut Speed	Voltage	Cut Speed	Voltage
	in	in	%	seconds	ipm	Volts	ipm	Volts
14GA	0.08	0.20	250	0.1	300	116	540	112
10GA				0.2	280	117	520	112
3/16 in					230	118	410	115
1/4 in				0.5	175	119	275	119
3/8 in					125	120	200	120
1/2 in		0.24	300	0.6	65	122	108	122
5/8 in		Edge Start			42	127	70	124
3/4 in		Edge Start			33	131	46	126
7/8 in		Edge Start			23	136	34	130
1 in		Edge Start			18	140	26	134

**85A Unshielded
Stainless Steel**

Air flow rate - slpm/scfh	
Hot	190 / 400
Cold	235 / 500

Metric

Material Thickness	Torch-to-Work Distance	Initial Pierce Height		Pierce Delay Time	Recommended		Maximum		
					Cut Speed	Voltage	Cut Speed	Voltage	
mm	mm	mm	%	seconds	(mm/min)	Volts	(mm/min)	Volts	
2	2.0	5.0	250	0.1	8550	117	14000	114	
3					7000	118	12000	116	
4				5600	118	9800	118		
6				0.5	3400	120	5700	122	
8					2250	121	3700	124	
10				6.0	300	0.5	1430	123	2300
12		0.7	1000			129	1700	127	
16		Edge Start				650	134	910	131
20						360	138	720	136

English

Material Thickness	Torch-to-Work Distance	Initial Pierce Height		Pierce Delay Time	Recommended		Maximum		
					Cut Speed	Voltage	Cut Speed	Voltage	
	in	in	%	seconds	ipm	Volts	ipm	Volts	
14GA	0.08	0.20	250	0.1	365	117	580	114	
10GA					280	120	460	116	
3/16 in				200	123	335	118		
1/4 in				0.5	110	126	215	119	
3/8 in					75	127	110	123	
1/2 in				0.24	300	0.6	45	135	78
5/8 in		Edge Start				34	139	56	132
3/4 in						22	143	40	136

TORCH SETUP

**85A Unshielded
Aluminum**

Air flow rate - slpm/scfh	
Hot	190 / 400
Cold	235 / 500

Metric

Material Thickness	Torch-to-Work Distance	Initial Pierce Height		Pierce Delay Time	Recommended		Maximum	
					Cut Speed	Voltage	Cut Speed	Voltage
mm	mm	mm	%	seconds	(mm/min)	Volts	(mm/min)	Volts
2	2.0	5.0	250	0.1	8700	118	14000	115
3					7350	120	12000	116
4				6000	122	10000	117	
6				3300	125	6150	119	
8		6.0	300	0.5	2350	127	4100	121
10					1800	128	2650	124
12				1300	133	2160	127	
16				Edge Start		840	139	1400
20	Edge Start		470	144	900	137		

English

Material Thickness	Torch-to-Work Distance	Initial Pierce Height		Pierce Delay Time	Recommended		Maximum	
					Cut Speed	Voltage	Cut Speed	Voltage
	in	in	%	seconds	ipm	Volts	ipm	Volts
1/8 in	0.08	0.20	250	0.2	280	120	460	116
3/16 in					200	123	335	118
1/4 in				110	126	215	119	
3/8 in				75	127	110	123	
1/2 in		0.24	300	0.6	45	135	78	128
5/8 in		Edge Start		34	139	56	132	
3/4 in		Edge Start		22	143	40	136	

65 A unshielded consumables

220955
Deflector

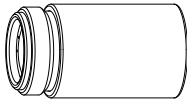

220854
Retaining cap



220819
Nozzle

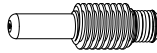

220842
Electrode

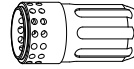

220857
Swirl ring

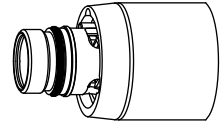

TORCH SETUP

**65A Unshielded
Mild Steel**

Air flow rate - slpm/scfh	
Hot	160 / 340
Cold	220 / 470

Metric

Material Thickness	Torch-to-Work Distance	Initial Pierce Height		Pierce Delay Time	Recommended		Maximum	
					Cut Speed	Voltage	Cut Speed	Voltage
mm	mm	mm	%	seconds	(mm/min)	Volts	(mm/min)	Volts
2	2.0	5.0	250	0.1	6050	117	9200	116
3				0.2	5200	118	7900	117
4				0.5	4250	118	6550	117
6					2550	120	4100	119
8					1620	123	2800	120
10		6.0	300	0.7	970	127	1880	122
12		Edge Start			760	129	1400	124
16					500	134	800	128
20					280	138	560	132

English

Material Thickness	Torch-to-Work Distance	Initial Pierce Height		Pierce Delay Time	Recommended		Maximum		
					Cut Speed	Voltage	Cut Speed	Voltage	
	in	in	%	seconds	ipm	Volts	ipm	Volts	
16GA	0.08	0.20	250	0.1	255	116	385	115	
10GA					190	118	290	117	
3/16 in				0.2	135	119	215	118	
1/4 in					0.5	90	120	145	119
3/8 in						40	126	78	121
1/2 in		0.24	300	0.7	27	130	50	125	
5/8 in		Edge Start			20	134	32	128	
3/4 in					13	137	22	131	

TORCH SETUP

**65A Unshielded
Stainless Steel**

Air flow rate - slpm/scfh	
Hot	160 / 340
Cold	220 / 470

Metric

Material Thickness	Torch-to-Work Distance	Initial Pierce Height		Pierce Delay Time	Recommended		Maximum	
					Cut Speed	Voltage	Cut Speed	Voltage
mm	mm	mm	%	seconds	(mm/min)	Volts	(mm/min)	Volts
2	2.0	5.0	250	0.1	7950	117	12800	119
3				0.2	6600	118	10600	119
4				0.5	5050	119	8200	119
6					2300	121	3800	120
8				0.7	1400	123	2400	121
10		6.0	300	0.7	920	126	1550	123
12		Edge Start			710	130	1150	127
16	Edge Start			480	135	630	132	

English

Material Thickness	Torch-to-Work Distance	Initial Pierce Height		Pierce Delay Time	Recommended		Maximum	
					Cut Speed	Voltage	Cut Speed	Voltage
	in	in	%	seconds	ipm	Volts	ipm	Volts
16GA	0.08	0.20	250	0.1	340	116	540	118
10GA					235	118	380	119
3/16 in				0.2	150	120	240	119
1/4 in				0.5	75	121	125	120
3/8 in		0.24	300	0.7	38	125	65	122
1/2 in		Edge Start			25	132	40	128
5/8 in		Edge Start			19	135	25	132

TORCH SETUP

**65A Unshielded
Aluminum**

Air flow rate - slpm/scfh	
Hot	160 / 340
Cold	220 / 470

Metric

Material Thickness	Torch-to-Work Distance	Initial Pierce Height		Pierce Delay Time	Recommended		Maximum	
					Cut Speed	Voltage	Cut Speed	Voltage
mm	mm	mm	%	seconds	(mm/min)	Volts	(mm/min)	Volts
2	2.0	5.0	250	0.1	7750	123	14200	123
3				0.2	6550	124	12000	123
4				0.5	5400	125	9500	123
6					3000	127	4850	124
8				0.7	1800	130	3000	126
10		6.0	300	0.7	1100	133	2050	127
12		Edge Start			900	135	1560	129
16		Edge Start			600	139	880	132

English

Material Thickness	Torch-to-Work Distance	Initial Pierce Height		Pierce Delay Time	Recommended		Maximum	
					Cut Speed	Voltage	Cut Speed	Voltage
	in	in	%	seconds	ipm	Volts	ipm	Volts
1/16 in	0.08	0.20	250	0.1	325	122	590	122
1/8 in					175	125	300	123
1/4 in				0.5	100	127	160	124
3/8 in		0.24	300	0.7	45	132	85	127
1/2 in		Edge Start			32	136	55	129
5/8 in		Edge Start			24	138	35	132

45 A unshielded consumables

220955
Deflector

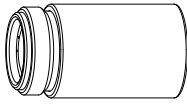

220854
Retaining cap



220941
Nozzle

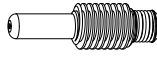

220842
Electrode

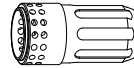

220857
Swirl ring

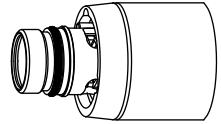

TORCH SETUP

**45A Unshielded
Mild Steel**

Air flow rate - slpm/scfh	
Hot	147 / 310
Cold	210 / 450

Metric

Material Thickness	Torch-to-Work Distance	Initial Pierce Height		Pierce Delay Time	Recommended		Maximum	
					Cut Speed	Voltage	Cut Speed	Voltage
mm	mm	mm	%	seconds	(mm/min)	Volts	(mm/min)	Volts
0.5	1.5	3.8	250	0.0	9000	120	12700	122
1					9000	120	12700	122
1.5				0.1	7700	120	12700	122
2					0.3	6150	119	9750
3				0.4	3950	121	6150	122
4					2350	123	4450	124
6				0.5	1400	126	2550	123

English

Material Thickness	Torch-to-Work Distance	Initial Pierce Height		Pierce Delay Time	Recommended		Maximum	
					Cut Speed	Voltage	Cut Speed	Voltage
	in	in	%	seconds	ipm	Volts	ipm	Volts
26GA	0.06	0.15	250	0.0	350	120	500	122
22GA					350	120	500	122
18GA				0.1	350	119	500	122
16GA					300	121	500	122
14GA				0.2	250	119	400	120
12GA				0.4	200	120	270	122
10GA					100	123	205	123
3/16 in				0.5	85	122	135	125
1/4 in				0.6	48	127	91	122

**45A Unshielded
Stainless Steel**

Air flow rate - slpm/scfh	
Hot	147 / 310
Cold	210 / 450

Metric

Material Thickness	Torch-to-Work Distance	Initial Pierce Height		Pierce Delay Time	Recommended		Maximum	
					Cut Speed	Voltage	Cut Speed	Voltage
mm	mm	mm	%	seconds	(mm/min)	Volts	(mm/min)	Volts
0.5	1.5	3.8	250	0.0	9000	121	12700	119
1					9000	121	12700	119
1.5				0.1	9000	121	12700	119
2					0.3	6000	122	12700
3				0.4	3250	123	5950	119
4					1900	128	3700	119
6				0.5	700	130	1800	127

English

Material Thickness	Torch-to-Work Distance	Initial Pierce Height		Pierce Delay Time	Recommended		Maximum	
					Cut Speed	Voltage	Cut Speed	Voltage
	in	in	%	seconds	ipm	Volts	ipm	Volts
26GA	0.06	0.15	250	0.0	350	120	500	119
22GA					350	120	500	119
18GA				0.1	350	118	500	119
16GA					350	121	500	119
14GA				0.2	300	122	500	117
12GA				0.4	150	121	280	119
10GA					100	125	175	119
3/16 in				0.5	42	131	110	120
1/4 in				0.6	25	130	60	129

TORCH SETUP

**45A Unshielded
Aluminum**

Air flow rate - slpm/scfh	
Hot	147 / 310
Cold	210 / 450

Metric

Material Thickness	Torch-to-Work Distance	Initial Pierce Height		Pierce Delay Time	Recommended		Maximum	
					Cut Speed	Voltage	Cut Speed	Voltage
mm	mm	mm	%	seconds	(mm/min)	Volts	(mm/min)	Volts
1	1.5	3.8	250	0.0	7400	126	12700	119
2				0.1	4400	127	11500	119
3				0.2	2800	129	7800	122
4				0.4	2100	132	5850	123
6				0.5	1050	135	2800	126

English

Material Thickness	Torch-to-Work Distance	Initial Pierce Height		Pierce Delay Time	Recommended		Maximum	
					Cut Speed	Voltage	Cut Speed	Voltage
	in	in	%	seconds	ipm	Volts	ipm	Volts
1/32 in	0.06	0.15	250	0.0	325	126	500	120
1/16 in				0.1	200	126	500	116
3/32 in				0.2	150	127	410	122
1/8 in				0.4	100	130	280	122
1/4 in				0.5	36	136	90	126

Section 4

OPERATION

In this section:

Controls and indicators	4-3
Rear controls	4-3
Front controls and LEDs	4-3
Status screen	4-6
Operating the Powermax65 or Powermax85	4-9
Connect the electrical power, gas supply, and torch lead	4-9
Attach the work lead to the power supply	4-10
Attach the work clamp to the workpiece	4-11
Turn ON the system	4-12
Set the operating mode switch	4-12
Check the indicators	4-13
Manually adjusting the gas pressure	4-13
Adjusting the current (amperage)	4-14
Understanding duty-cycle limitations	4-15
Using the hand torch	4-16
Operate the safety trigger	4-16
Hand torch cutting hints	4-17
Start a cut from the edge of the workpiece	4-18
Pierce a workpiece	4-19
Gouge a workpiece	4-20
Common hand-cutting faults	4-23

OPERATION

Using the machine torch	4-24
Ensure the torch and table are set up correctly	4-24
Understand and optimize cut quality.....	4-24
To pierce a workpiece using the machine torch	4-27
Common machine-cutting faults.....	4-27

Controls and indicators

The Powermax65 and Powermax85 power supplies have the following: ON/OFF switch, adjustment knob, automatic/manual pressure setting mode selector, current/gas selector, operating mode switch, indicator LEDs, and a status screen.

Rear controls

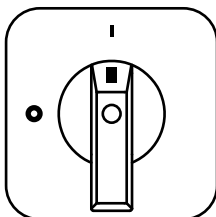

ON (I)/OFF (O) power switch

Activates the power supply and its control circuits.

Front controls and LEDs

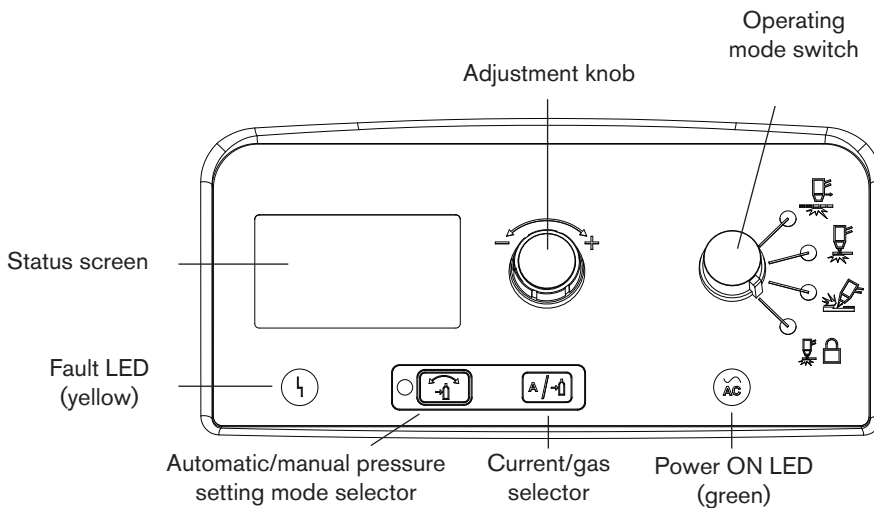

OPERATION



Fault LED (yellow)

When illuminated, this LED indicates that there is a fault with the power supply. For information about these fault conditions and how to correct them, see “Basic troubleshooting” on page 5-4.



Power ON LED (green)

When illuminated, this LED indicates that the power switch has been set to I (ON) and that the safety interlocks are satisfied. When blinking, the power supply has a fault.

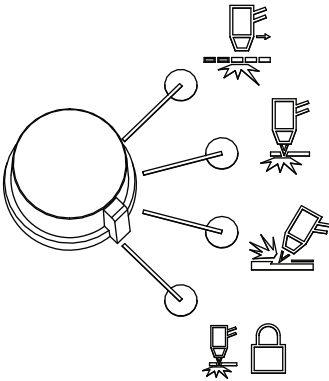

Operating mode switch

The operating mode switch can be set in one of four positions:

- Continuous pilot arc. Cuts expanded metal or grate.
- Non-continuous pilot arc. Cuts or pierces metal plate. This is the standard setting for normal drag-cutting.
- Gouge. Gouges metal plate.
- Torch lock. Same as the non-continuous pilot arc mode except the torch is locked in the ON position when you release the trigger during a cut.

**Automatic/manual pressure setting mode selector**

The selector switches between automatic and manual mode. In automatic mode, the power supply automatically sets the gas pressure based upon the torch type and lead length and the adjustment knob sets only the amperage. In manual mode, the adjustment knob sets either the gas pressure or the amperage. This LED is illuminated in manual mode.

Note: Manual mode should be used by experienced users who need to optimize the gas setting (override the automatic gas setting) for a specific cutting application.

When you switch from manual mode to automatic mode, the power supply automatically sets the gas pressure and the amperage setting is unchanged. When you switch from automatic mode to manual mode, the power supply remembers the previous manual gas pressure setting and the amperage setting is unchanged.

When you reset the power, the power supply remembers the previous mode, gas pressure, and amperage settings.

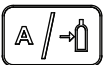
**Current/gas selector**

When in manual mode, this selector toggles between amperage and gas pressure for manual adjustments using the adjustment knob.

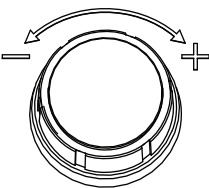
**Adjustment knob**

This knob adjusts the amperage. When operating in manual mode, this knob can also adjust the gas pressure, overriding the automatic setting for optimized applications.

OPERATION

Status screen

The status screen shows system status and fault information.

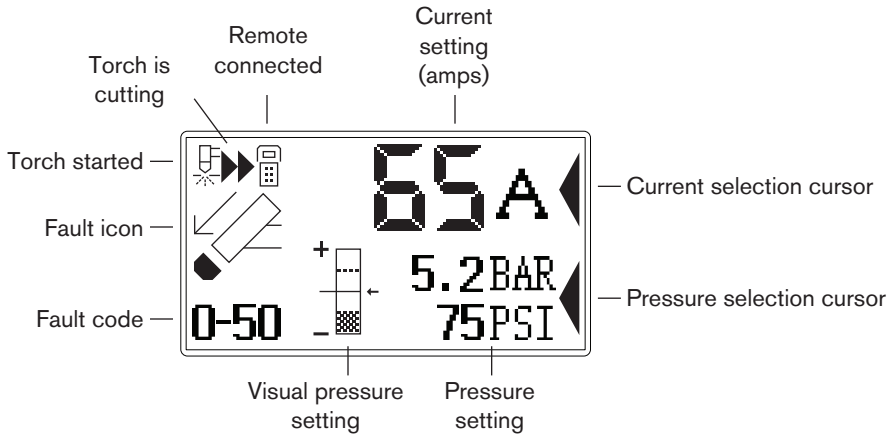

Gas pressure indicators

In manual mode, the gas pressure is displayed in bar and psi. The gas pressure bar is also a visual indicator of the gas pressure.

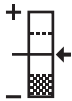
**Gas pressure bar**

When the arrow is centered in the vertical bar (the reference pressure of the automatic pressure setting), the gas pressure is set to the preset (factory-defined) value. If the pressure is higher than the preset value, the arrow appears above the mid-point of the bar. If the pressure is lower than the preset value, the arrow appears below the mid-point of the bar.

Note: In automatic mode, the power supply adjusts the pressure to the preset value. You can use manual mode to adjust the pressure to satisfy the needs of a particular cutting job. Refer to “Manually adjusting the gas pressure” on page 4-13.

System status icons

The screen displays icons to indicate the system’s status.

**Torch started**

Indicates that the torch has received a start signal and has initiated a pilot arc.

**Torch is cutting**

Indicates that the cutting arc has transferred to the metal and the torch is cutting.

**Remote control**

Indicates that a remote control is controlling the power supply. All local controls are disabled.

Fault codes

When a power supply or torch fault occurs, the system displays a fault code in the lower-left corner of the status screen and displays a corresponding fault icon above the code. The first digit is always zero. The other two digits identify the problem. Refer to “Basic troubleshooting” on page 5-4.

Note: Only one fault code is displayed. If more than one fault occurs at the same time, only the fault code with the highest priority is displayed.

Fault icons

The fault icons that appear on the left side of the status screen are described below. A fault code also appears to identify the fault. Refer to “Basic troubleshooting” on page 5-4.



Warning

The system continues to run.



Fault

The system stops cutting. If you can not correct the problem and restart the system, contact your distributor or Hypertherm Technical Service.



Error

The system requires service. Contact your distributor or Hypertherm Technical Service.



Torch cap sensor

Indicates that the consumables are loose, improperly installed, or missing. Turn OFF the power, properly install the consumables, and turn ON the system again to reset the power supply.



Temperature

Indicates that the temperature of the power supply power module is outside the acceptable operating range.



Gas

Indicates that the gas is disconnected from the rear of the power supply or there is a problem with the gas supply.

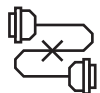

Internal Serial Communications Interface

Indicates a problem with the SCI communications between the control board and the DSP board.

Operating the Powermax65 or Powermax85

Follow the steps below to begin cutting or gouging with the Powermax65 or Powermax85.

Connect the electrical power, gas supply, and torch lead

For information on connecting the proper power cord with plug to the power supply, refer to the section “Power connection for the Powermax65” on page 2-6 or “Power connection for the Powermax85” on page 2-8.

Plug in the power cord and connect the gas supply line. For more information about the electrical requirements and the gas supply requirements of the Powermax65 and Powermax85, see *Section 2, Power Supply Setup*. To connect the torch, push the FastConnect™ connector into the receptacle on the front of the power supply. You will attach the work lead in the next section.

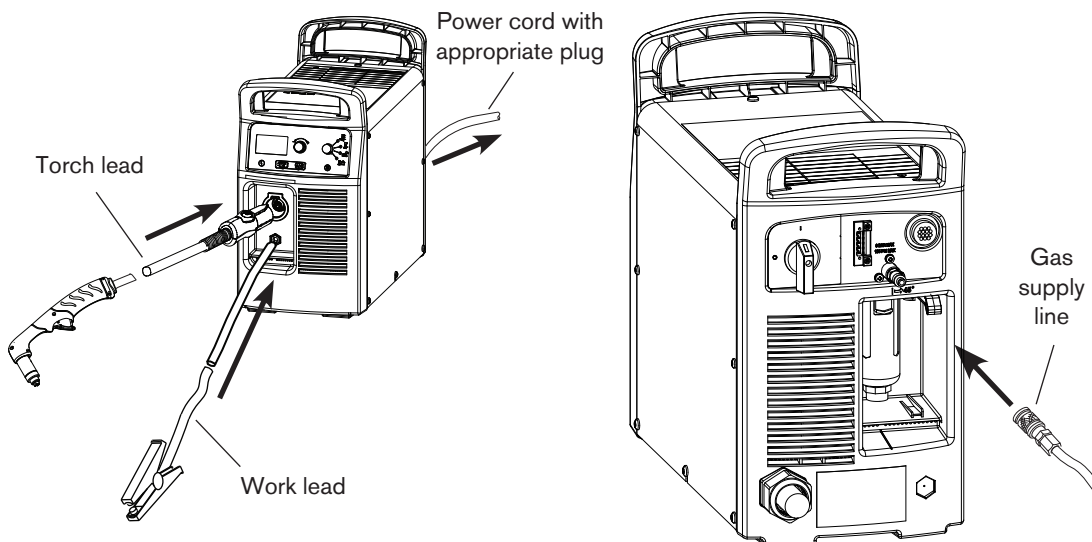

OPERATION

Attach the work lead to the power supply



Caution: Make sure you use a work lead that is appropriate for your power supply. Use a 65 A work lead with the Powermax65. Use an 85 A work lead with the Powermax85. The amperage is marked near the rubber boot of the work lead connector.

1. Insert the work lead connector into the receptacle on the front of the power supply.

Note: The receptacle is keyed. Align the key on the work lead connector with the opening at the top of the receptacle on the power supply.

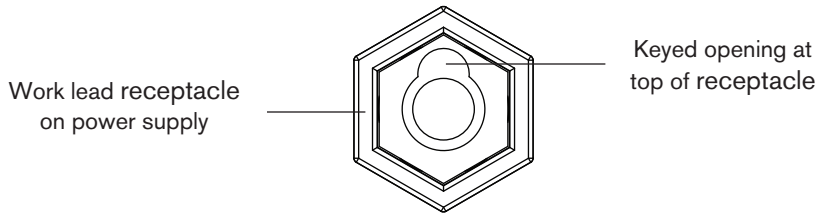

2. Push the work lead connector all the way into the receptacle on the power supply and turn clockwise, approximately 1/4 turn, until the connector is fully seated against the stop in order to achieve an optimal electrical connection.



Caution: Ensure the work lead is fully seated in the receptacle to prevent overheating.

Attach the work clamp to the workpiece

The work clamp must be connected to the workpiece while you are cutting. If you are using the Powermax65 or Powermax85 with a cutting table, you can connect the work lead directly to the table instead of attaching the work clamp to the workpiece. See your table manufacturer's instructions.

Note the following:

- Ensure that the work clamp and the workpiece make good metal-to-metal contact. Remove rust, dirt, paint, coatings, and other debris to ensure the power supply makes proper contact with the workpiece.
- For the best cut quality, attach the work clamp as close as possible to the area being cut.
- **Do not attach the work clamp to the portion of the workpiece to be cut away.**

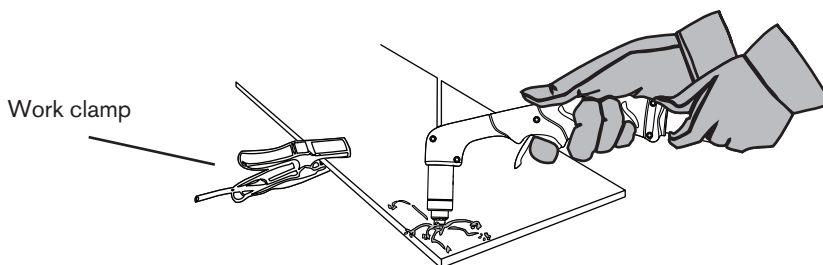

OPERATION

Turn ON the system

Set the ON/OFF switch to the ON (I) position.

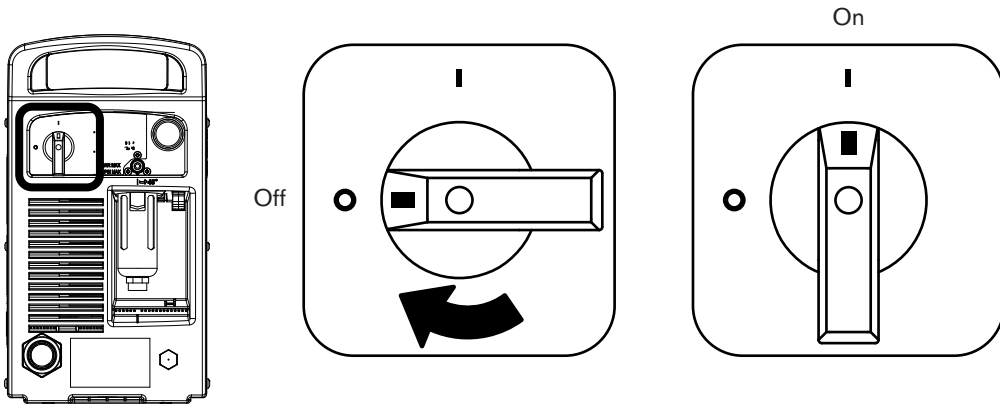

Set the operating mode switch

Use the operating mode switch to select the type of work you want to perform.

In automatic gas mode, Smart Sense™ technology automatically adjusts the gas pressure according to the selected cutting mode and torch lead length for optimum cutting.

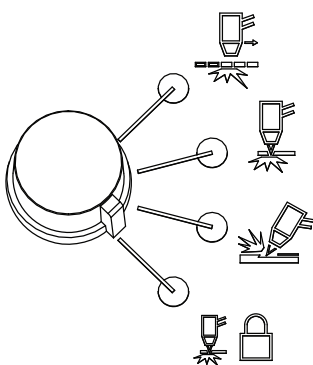

For cutting expanded metal, grates, metal containing holes, or any job that requires a continuous pilot arc. Using this mode to cut standard metal plate reduces consumable life.

For cutting or piercing metal. This is the standard setting for normal drag-cutting.

For gouging metal. (Note: Using this mode while cutting results in poor cut quality.)

Locks the torch in the ON (fire) position. With this option selected, press the trigger to fire the torch. You can then release the trigger while continuing to cut. Press the trigger again to stop the arc. The arc also stops if you lose transfer.

Check the indicators

Verify the following:

- The green power ON LED on the front of the power supply is illuminated.
- The Fault LED is *not* illuminated.
- No error icons appear in the status screen.

If a fault icon appears in the status screen, or the Fault LED is illuminated, or the power ON LED is blinking, correct the fault condition before continuing. See “Basic troubleshooting” on page 5-4 for more information.

Manually adjusting the gas pressure

For normal operations, the power supply automatically adjusts the gas pressure. If you need to adjust the gas pressure for a specific application, you can use manual mode to do so.

Note: Manual mode should be used by experienced users who need to optimize the gas setting (override the automatic gas setting) for a specific cutting application.

When you switch from manual mode to automatic mode, the power supply automatically sets the gas pressure and the amperage setting is unchanged. When you switch from automatic mode to manual mode, the power supply remembers the previous manual gas pressure setting and the amperage setting is unchanged.

When you reset the power, the power supply remembers the previous mode, gas pressure, and amperage settings.

To adjust the pressure:

1. Press the automatic/manual pressure setting mode selector so that the LED next to the selector illuminates. Refer to the diagram in “Front controls and LEDs” on page 4-3.
2. Press the current/gas selector until the selection cursor is opposite the gas pressure setting in the status screen.
3. Turn the adjustment knob to adjust the gas pressure to the desired level. Watch the arrow in the pressure bar as you adjust the pressure.

Adjusting the current (amperage)

Turn the adjustment knob to adjust the current for your particular cutting application.

If the system is in manual mode, do the following to adjust the amperage.

1. Press the current/gas selector until the selection cursor is opposite the amperage setting in the status screen.
2. Turn the adjustment knob to change the amperage.
3. If you wish to exit manual mode, press the automatic/manual pressure setting mode selector. The LED goes off.

Note: When you exit manual mode, the gas pressure resets to the factory-optimized value.

When you switch between manual mode and automatic mode, the power supply retains the amperage setting. When you reset the power, the power supply returns to the previous mode (automatic mode or manual mode) and remembers the previous amperage setting.

Understanding duty-cycle limitations

The duty cycle is the amount of time, in minutes, that a plasma arc can remain on within a 10-minute period when operating at an ambient temperature of 104° F (40° C).

With a Powermax65:



- At 65 A, the arc can remain on for 5 minutes out of 10 minutes without causing the unit to overheat (50% duty cycle).
- At 59 A, the arc can remain on for 6 minutes out of 10 (60%)
- At 46 A, the arc can remain on for 10 minutes out of 10 (100%).

With a Powermax85:

- At 85 A, the arc can remain on for 6 minutes out of 10 minutes without causing the unit to overheat (60% duty cycle).
- At 74 A, the arc can remain on for 8 minutes out of 10 (80%)
- At 66 A, the arc can remain on for 10 minutes out of 10 (100%).

If the duty cycle is exceeded, the power supply overheats, the temperature fault icon appears in the status screen, the arc shuts off, and the cooling fan continues to run. You can not resume cutting until the temperature fault icon disappears and the fault LED goes off.

Using the hand torch

		WARNING INSTANT-ON TORCHES PLASMA ARC CAN CAUSE INJURY AND BURNS
<p>Plasma arc comes on immediately when the torch trigger is activated. The plasma arc will cut quickly through gloves and skin.</p> <ul style="list-style-type: none">▪ Wear correct and appropriate protective equipment.▪ Keep away from the torch tip.▪ Do not hold the workpiece and keep your hands clear of the cutting path.▪ Never point the torch toward yourself or others.		

Operate the safety trigger

The hand torches are equipped with a safety trigger to prevent accidental firings. When you are ready to use the torch, flip the trigger's safety cover forward (toward the torch head) and press the red torch trigger as show below.

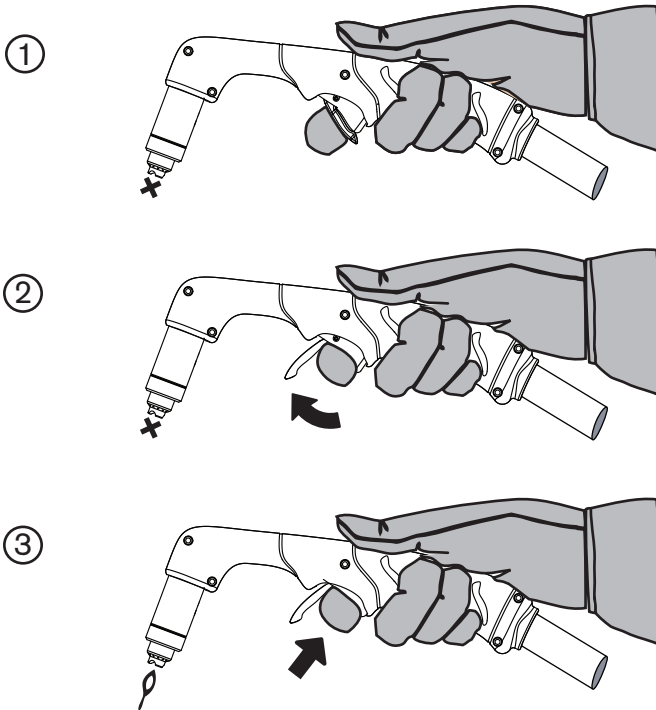

Hand torch cutting hints

- Drag the torch tip lightly along the workpiece to maintain a steady cut.
- While cutting, make sure that sparks exit from the bottom of the workpiece. The sparks should lag slightly behind the torch as you cut (15° — 30° angle from vertical).
- If sparks spray up from the workpiece, move the torch more slowly, or set the output current higher.

- With either the 75-degree or 15-degree hand torch, hold the torch nozzle perpendicular to the workpiece so that the nozzle is at a 90° angle to the cutting surface. Observe the cutting arc as the torch cuts.

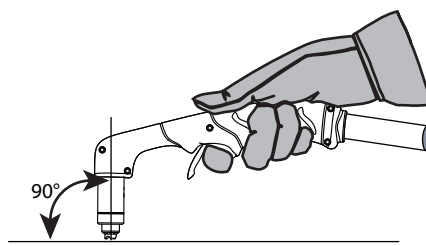

- If you fire the torch unnecessarily, you will shorten the life of the nozzle and electrode.

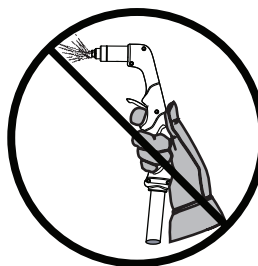

- Pulling, or dragging, the torch along the cut is easier than pushing it.
- For straight-line cuts, use a straight edge as a guide. To cut circles, use a template or a radius cutter attachment (a circle cutting guide). See Section 6, *Parts*, for part numbers for the Hypertherm plasma cutting guides for cutting circles and making bevel cuts.

OPERATION

Start a cut from the edge of the workpiece

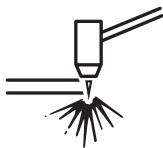

1. With the work clamp attached to the workpiece, hold the torch nozzle perpendicular (90°) to the edge of the workpiece.



2. Press the torch's trigger to start the arc. Pause at the edge until the arc has cut completely through the workpiece.



3. Drag the torch tip lightly across the workpiece to proceed with the cut. Maintain a steady, even pace.



Pierce a workpiece

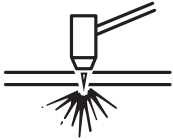

WARNING

SPARKS AND HOT METAL CAN INJURE EYES AND BURN SKIN. When firing the torch at an angle, sparks and hot metal will spray out from the nozzle. Point the torch away from yourself and others.

1. With the work clamp attached to the workpiece, hold the torch at an approximate 30° angle to the workpiece with the torch tip within 1/16 inch (1.5 mm) of the workpiece before firing the torch.
2. Fire the torch while still at an angle to the workpiece. Slowly rotate the torch to a perpendicular (90°) position.
3. Hold the torch in place while continuing to press the trigger. When sparks exit below the workpiece, the arc has pierced the material.
4. When the pierce is complete, drag the nozzle lightly along the workpiece to proceed with the cut.



Gouge a workpiece



		WARNING
SPARKS AND HOT METAL CAN INJURE EYES AND BURN SKIN. When firing the torch at an angle, sparks and hot metal will spray out from the nozzle. Point the torch away from yourself and others.		

1. Hold the torch so that the torch tip is within 1/16 inch (1.5 mm) from the workpiece before firing the torch.

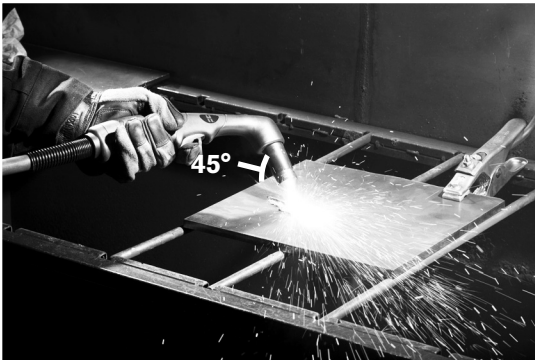

2. Hold the torch at a 45° angle to the workpiece with a small gap between the torch tip and the workpiece. Press the trigger to obtain a pilot arc. Transfer the arc to the work piece.



3. Maintain an approximate 45° angle to the workpiece as you feed into the gouge. Push the plasma arc in the direction of the gouge you want to create. Keep a small distance between the torch tip and the molten metal to avoid reducing consumable life or damaging the torch.

Changing the torch's angle changes the dimensions of the gouge.

Gouge profile

You can vary the gouge profile by varying the speed of the torch over the workpiece, varying the torch-to-work standoff distance, varying the angle of the torch to the workpiece, and varying the current output of the power supply.

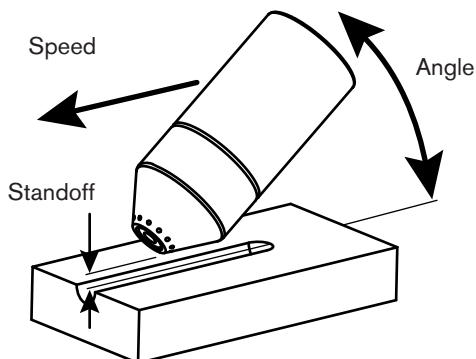

Typical Gouge Profile for 65 A

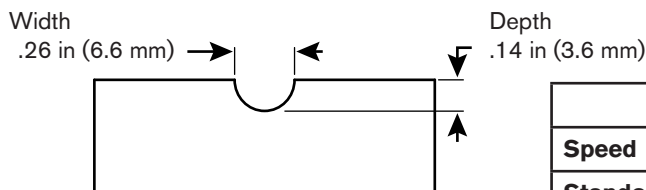

Operating parameters	
Speed	20-25 ipm (50.8-63.5 cm/min)
Standoff	1/4-3/8 in (6.4-9.5 mm)
Angle	35-40°

Typical Gouge Profile for 85 A

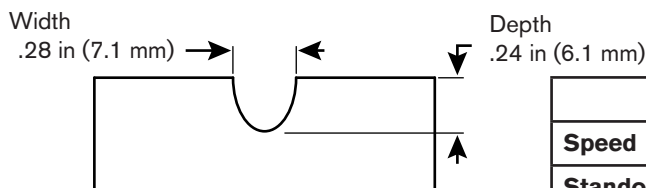

Operating parameters	
Speed	20-25 ipm (50.8-63.5 cm/min)
Standoff	1/4-3/8 in (6.4-9.5 mm)
Angle	35-40°

Varying the gouge profile

The following actions have the stated effects on the gouge profile:

- **Increasing the speed** of the torch will **decrease width** and **decrease depth**.
- **Decreasing the speed** of the torch will **increase width** and **increase depth**.
- **Increasing the standoff** of the torch will **increase width** and **decrease depth**.
- **Decreasing the standoff** of the torch will **decrease width** and **increase depth**.
- **Increasing the angle** of the torch (more vertical) will **decrease width** and **increase depth**.
- **Decreasing the angle** of the torch (less vertical) will **increase width** and **decrease depth**.
- **Increasing the current** of the power supply will **increase width** and **increase depth**.
- **Decreasing the current** of the power supply will **decrease width** and **decrease depth**.

Common hand-cutting faults

The torch does not cut completely through the workpiece. The causes can be:

- The cut speed is too fast.
- The consumables are worn.
- The metal being cut is too thick for the selected amperage.
- Gouging consumables are installed instead of drag-cutting consumables.
- The work clamp is not attached properly to the workpiece.
- The gas pressure or gas flow rate is too low.

Cut quality is poor. The causes can be:

- The metal being cut is too thick for the amperage.
- The wrong consumables are being used (gouging consumables are installed instead of drag-cutting consumables, for example).
- You are moving the torch too quickly or too slowly.

The arc sputters and consumables life is shorter than expected. The cause can be:

- Moisture in the gas supply.
- Incorrect gas pressure.
- Consumables incorrectly installed.

Using the machine torch

Since the Powermax with a machine torch can be used with a wide variety of cutting tables, track burners, pipe bevelers, and so on, you will need to refer to the manufacturer's instructions for specifics on operating the machine torch in your configuration. However, the information in the following sections will help you optimize cut quality and maximize consumable life.

Ensure the torch and table are set up correctly

- Use a square to align the torch at right angles to the workpiece in two dimensions.
- The torch may travel more smoothly if you clean, check and “tune” the cutting table's rails and drive system. Unsteady machine motion can cause a regular, wavy pattern on the cut surface.
- Ensure that the torch does not touch the workpiece during cutting. Contact with the workpiece can damage the shield and nozzle and affect the cut surface.

Understand and optimize cut quality

There are several factors to consider in cut quality:

- Cut angle — The degree of angularity of the cut edge.
- Dross — The molten material that solidifies on the top or bottom of the workpiece.
- Straightness of the cut surface — The cut surface can be concave or convex.

The following sections explain how these factors can affect cut quality.

Cut or bevel angle

- A positive cut angle, or bevel, results when more material is removed from the top of the cut than from the bottom.
- A negative cut angle results when more material is removed from the bottom of the cut.

Problem		Cause	Solution
Negative cut angle		The torch is too low.	Raise the torch; or if you are using a torch height control, increase the arc voltage.
Square cut	The torch is too high.	Lower the torch; or if you are using a torch height control, decrease the arc voltage.	
Positive cut angle			

Note: The squarest cut angle will be on the *right* side with respect to the forward motion of the torch. The left side will always have some degree of bevel.

To determine whether a cut-angle problem is being caused by the plasma system or the drive system, make a test cut and measure the angle of each side. Next, rotate the torch 90° in its holder and repeat the process. If the angles are the same in both tests, the problem is in the drive system.

If a cut-angle problem persists after “mechanical causes” have been eliminated (see “Ensure the torch and table are set up correctly” on page 4-24), check the torch-to-work distance, especially if the cut angles are all positive or all negative. Also consider the material being cut: if the metal is magnetized or hardened, you are more likely to experience cut angle problems.

Dross

Some amount of dross will always be present when cutting with air plasma. However, you can minimize the amount and type of dross by adjusting your system correctly for your application.

Excess dross appears on the top edge of both pieces of the plate when the torch is too low (or voltage is too low when using a torch height control). Adjust the torch or adjust the voltage in small increments (5 volts or less) until the dross is reduced.

Low-speed dross forms when the torch’s cutting speed is too slow and the arc angles ahead. It forms as a heavy, bubbly deposit at the bottom of the cut and can be removed easily. Increase the speed to reduce this type of dross.

OPERATION



High-speed dross forms when the cutting speed is too fast and the arc angles behind. It forms as a thin, linear bead of solid metal attached very close to the cut. It is more firmly attached to the bottom of the cut than at low speed and is difficult to remove. To reduce high-speed dross:

- Decrease the cutting speed.
- Decrease the torch-to-work distance.

Note: Dross is more likely to form on warm or hot metal than on cool metal. For example, the first cut in a series of cuts usually produces the least dross. As the workpiece heats up, more dross can accumulate on subsequent cuts.

Worn or damaged consumables may produce excess dross.

Straightness of the cut surface

	A typical plasma cut surface is slightly concave. The cut surface may become more concave, or convex. Correct torch height is required to keep the cut surface acceptably close to straight. Worn consumables also affect the straightness of the cut.
	A strongly concave cut surface occurs when the torch-to-work distance is too low. Increase the torch-to-work distance to straighten the cut surface.
	A convex cut surface occurs when the torch-to-work distance is too great or the cutting current is too high. First, try lowering the torch, then reduce the cutting current.

To pierce a workpiece using the machine torch

As with the hand torch, you can start a cut with the machine torch at the edge of the workpiece or by piercing the workpiece. Piercing will result in a shorter consumable life than with edge starts.

The cut charts include a column for the recommended torch height when starting a pierce. For the Powermax65 and Powermax85, the pierce height is generally 2.5 times the cutting height. Refer to the cut charts for specifics.

The pierce delay must be sufficiently long that the arc can pierce the material before the torch moves, but not so long that the arc “wanders” while trying to find the edge of a large hole.

When piercing maximum thicknesses, the ring of dross that forms during the pierce may become high enough to contact the torch when the torch begins to move after the pierce is complete. Remove the dross if the torch will contact it during the cut.

Common machine-cutting faults

The torch's pilot arc will initiate, but will not transfer. Causes can be:

- The work cable is not making good contact with the cutting table or the cutting table is not making good contact with the workpiece.
- The torch-to-work distance is too large.

The workpiece is not totally penetrated, and there is excessive sparking on the top of the workpiece. Causes can be:

- The consumables are worn and need to be replaced. For optimized performance in a mechanized application, replace the nozzle and the electrode together.
- The work cable is not making good contact with the cutting table or the cutting table is not making good contact with the workpiece.
- The current (amperage) is set too low. See “Using the cut charts” on page 3-25 for more information.
- The cut speed is too high. See “Using the cut charts” on page 3-25 for more information.
- The metal being cut exceeds the maximum capacity for the selected amperage. See “Powermax65 cutting specifications” on page 1-12 or “Powermax85 cutting specifications” on page 1-13.

OPERATION

Dross forms on the bottom of the cut. Causes can be:

- The consumables are worn and need to be replaced. For optimized performance in a mechanized application, replace the nozzle and the electrode together.
- The cutting speed is not correct. See “Using the cut charts” on page 3-25 for more information.
- The current (amperage) is set too low. See “Using the cut charts” on page 3-25 for more information.

The cut angle is not square. Causes can be:

- The consumables are worn and need to be replaced. For optimized performance in a mechanized application, replace the nozzle and the electrode together.
- The direction of the torch travel is incorrect. The high-quality cut is always on the right with respect to the forward motion of the torch.
- The distance between the torch and the workpiece is not correct.
- The cutting speed is not correct. See “Using the cut charts” on page 3-25 for more information.

The consumables' life is shortened. Causes can be:

- The arc current, arc voltage, travel speed, and other variables are not set as recommended in the cut charts.
- Firing the arc in the air (beginning or ending the cut off of the plate surface). Starting at the edge is acceptable as long as the arc makes contact with the workpiece when started.
- Starting a pierce with an incorrect torch height. Refer to the cut charts for the specific initial pierce height.



Section 5

MAINTENANCE AND REPAIR

In this section:

Perform routine maintenance	5-2
Inspect the consumables	5-3
Basic troubleshooting.....	5-4
Fault codes and solutions	5-6
Replace the gas filter element	5-10

Perform routine maintenance

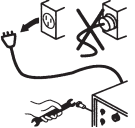
		DANGER ELECTRIC SHOCK CAN KILL
	Disconnect the electrical power before you perform any maintenance. All work that requires removal of the power supply cover must be performed by a qualified technician.	

Every use:

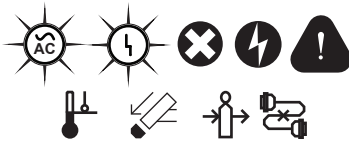

Check indicator lights and fault icons.
Correct any fault conditions.

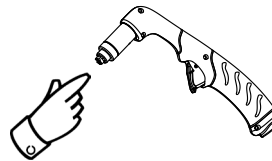

Inspect the consumables for proper installation and wear.

Every 3 months:



Replace any damaged labels.

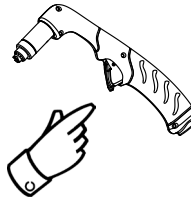

Inspect the trigger for damage. Inspect the torch body for cracks and exposed wires. Replace any damaged parts.



Inspect the power cord and plug. Replace if damaged.

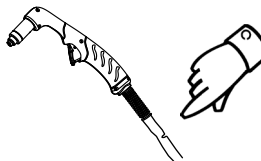



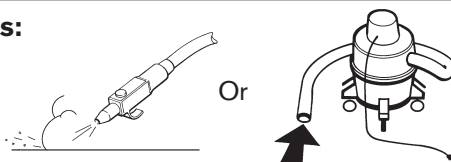

Inspect the torch lead.
Replace if damaged.

Every 6 months:

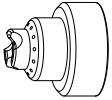

Clean the inside of the power supply with compressed air or a vacuum.

Inspect the consumables

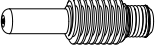
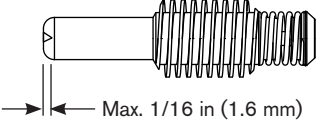
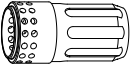
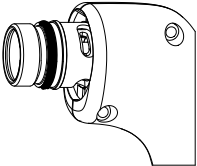
Part	Inspect	Action
	<p>Shield or deflector</p> <p>The center hole for roundness.</p> <p>The gap between the shield and the nozzle for accumulated debris.</p>	<p>Replace the shield if the hole is no longer round.</p> <p>Remove the shield and clean away any material.</p>
	<p>Nozzle</p> <p>The center hole for roundness.</p> <div style="display: flex; justify-content: space-around; align-items: center;"> <div style="text-align: center;">  <p>Good</p> </div> <div style="text-align: center;">  <p>Worn</p> </div> </div>	<p>Replace nozzle if the center hole is not round.</p>
	<p>Electrode</p>  <p>Max. 1/16 in (1.6 mm)</p>	<p>Replace electrode if the surface is worn or the pit depth is greater than 1/16 inch (1.6 mm) deep.</p>
	<p>Swirl ring</p> <p>The surface inside the swirl ring for damage or wear and the gas holes for blockages.</p>	<p>Replace swirl ring if the surface is damaged or worn or any of the gas holes are blocked.</p>
	<p>Torch o-ring</p> <p>The surface for damage, wear, or a lack of lubrication.</p>	<p>If the o-ring is dry, lubricate it and the threads with a thin layer of silicone lubricant. If the o-ring is worn or damaged, replace it.</p>

Basic troubleshooting

The following table provides an overview of the most common problems that can arise when using the Powermax65 or Powermax85 and explains how to solve them.

Note: Fault icons and corresponding fault codes appear in the LCD display. Refer to “Fault codes and solutions” on page 5-6.

If you are unable to fix the problem by following this basic troubleshooting guide, or if you need further assistance:





1. Call your Hypertherm distributor or authorized Hypertherm repair facility.
2. Call the nearest Hypertherm office listed in the front of this manual.



Problem	Solutions
The ON/OFF power switch is set to ON (I), but the power ON LED is not illuminated.	<ul style="list-style-type: none">▪ Verify that the power cord is plugged into the receptacle.▪ Verify that the power is ON at the main power panel or at the line-disconnect switch box.▪ Verify that the line voltage is not too low (more than 15% below the rated voltage).▪ Verify that the circuit break has not been tripped.
The arc does not transfer to the workpiece.	<ul style="list-style-type: none">▪ Clean the area where the work clamp contacts the workpiece to ensure a good metal-to-metal connection.▪ Inspect the work clamp for damage and repair as necessary.▪ The pierce-height distance may be too large. Move the torch closer to the workpiece and fire the torch again.

Problem	Solutions
The arc blows out, but re-ignites when the torch trigger is pressed again.	<ul style="list-style-type: none">▪ Inspect the consumable parts and replace them if they are worn or damaged. See “Inspect the consumables” on page 5-3.▪ Replace the gas filter’s element if it is contaminated. See “Replace the gas filter element” on page 5-10.▪ Make sure the gas pressure is at the proper level.
The arc sputters and hisses.	<ul style="list-style-type: none">▪ The gas filter’s element is contaminated. Replace the element. See “Replace the gas filter element” on page 5-10.▪ Inspect the gas line for moisture. If necessary, install or repair the gas filtration to the power supply. See “Prepare the gas supply” on page 2-14.
The cut quality is poor.	<ul style="list-style-type: none">▪ Verify that the torch is being used correctly. See Section 4, <i>Operation</i>.▪ Inspect the consumables for wear and replace as necessary. See “Inspect the consumables” on page 5-3.▪ Check the air pressure and air quality.▪ Verify that the cutting mode switch is in the proper position for the cutting operation.▪ Verify that the correct consumables are installed.



Fault codes and solutions





A label with descriptions for these common fault codes can be found inside the front cover of this manual. Peel off the label and place it on the rear of the power supply for reference.

Fault code	Description	Power LED	Fault LED	Fault icon	Solutions
0-12	Low input gas pressure: Warning (the system continues to operate)	On	Off		<ul style="list-style-type: none">▪ Adjust the gas inlet pressure as needed.
0-13	AC input unstable: Warning (the system continues to operate)	Blink fast	Off		<ul style="list-style-type: none">▪ Correct the power source.
0-20	Low gas pressure	On	On		<ul style="list-style-type: none">▪ Check the input gas supply.▪ Adjust the gas pressure to the acceptable range using Manual mode. See "Manually adjusting the gas pressure" on page 4-13.
0-21	Gas flow lost while cutting	On	On		<ul style="list-style-type: none">▪ Restore the gas inlet pressure and restart the power supply.▪ Check the torch lead for leaks or kinking.
0-22	No gas input	On	On		<ul style="list-style-type: none">▪ Connect the gas source and restart the power supply.

Fault code	Description	Power LED	Fault LED	Fault icon	Solutions
0-30	<p>Torch consumables stuck</p> <p>This indicates either a “torch stuck open” or a “torch stuck closed” situation.</p>	On	On		<ul style="list-style-type: none"> ▪ If the consumables became loose or were removed while the power supply is ON, turn OFF the power supply, correct the problem and then turn ON the power supply to clear this fault. ▪ If the consumables appear to be installed correctly, the torch may be damaged. Contact your Hypertherm distributor or authorized repair facility.
0-40	Over/under temperature	On	On		<ul style="list-style-type: none"> ▪ Leave the power supply on to allow the fan to cool the power supply. ▪ If the internal temperature of the power supply approaches -22° F (-30° C), move the power supply to a warmer location.

MAINTENANCE AND REPAIR

Fault code	Description	Power LED	Fault LED	Fault icon	Solutions
0-50	Retaining cap off	On	On		<ul style="list-style-type: none">▪ Turn OFF the power supply. Verify that the consumables are installed and restart the power supply.▪ If the consumables appear to be installed correctly, the torch may be damaged. Contact your Hypertherm distributor or authorized repair facility.
0-51	Start/trigger signal on at power up This situation indicates that the power supply is receiving a start signal. It is sometimes referred to as a "stuck start."	On	On		<ul style="list-style-type: none">▪ If the power supply is turned on while the torch trigger is pressed, the system is disabled. Release the trigger and recycle the power switch.

Fault code	Description	Power LED	Fault LED	Fault icon	Solutions
0-52	Torch not connected	On	On		<ul style="list-style-type: none"> ▪ Plug a torch lead into the FastConnect receptacle on the front of the power supply and recycle the power switch.
0-60	AC input voltage error	On	On		<ul style="list-style-type: none"> ▪ Phase loss: Check all input phases and fuses. ▪ Over voltage: Check the line, decrease the voltage. ▪ Under voltage: Check the line, increase the voltage.
0-61	AC input unstable: Shutdown	On	On		<ul style="list-style-type: none"> ▪ The incoming line current is unstable. Power down and correct the line problem before continuing.
0-98	Internal communication failure	On	On		<ul style="list-style-type: none"> ▪ Power down, wait 20 seconds, power up. ▪ A qualified service technician must open the power supply case and check the ribbon cable between the control board and the DSP board.
0-99	System hardware fault — service required Indicates a major fault with the system.	On	On		<ul style="list-style-type: none"> ▪ A qualified service technician must service the system. Contact your distributor or authorized repair facility.

Replace the gas filter element

1. Turn OFF the power, disconnect the power cord, and make sure the gas supply is disconnected.
2. Position the rear of the power supply so the removable gas filter bowl is easily accessible.
3. Grasp the filter bowl with your right hand.
4. Push down the thumb latch and rotate the filter bowl approximately 45 degrees to the right.
5. Pull the filter bowl straight down to remove. You can see the white filter element and retaining nut.
6. Unscrew (counterclockwise) the plastic retaining nut that secures the filter element.
7. Replace the dirty element with a new element. Reinstall (clockwise) the plastic retaining nut to finger-tight only.
8. Insert the filter bowl with the thumb latch positioned approximately 45 degrees to the right of center. This is the same orientation in which the filter bowl was pulled down and removed.
9. Vertically align the filter bowl (with metal guard) and firmly push the filter bowl up to the top of the receptacle to seat the bowl. It is helpful to lift the bowl with your left index finger under the nut on the bottom of the bowl.
10. Once the bowl is seated properly, rotate the bowl 45 degrees to the left until you hear the thumb latch click into place.
11. Reconnect the gas supply hose to the power supply and check for leaks.
12. Reconnect the electrical power and turn ON the power switch.

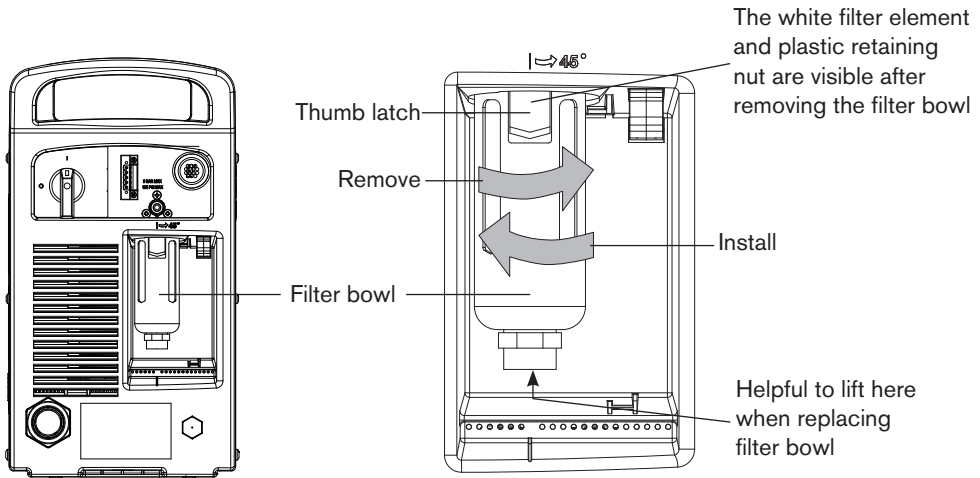

Section 6

PARTS

In this section:

Power supply parts.....	6-2
Hand torch replacement parts	6-5
H65/H85	6-5
H65s/H85s.....	6-5
Hand torch consumables	6-8
Machine torch replacement parts	6-9
M65/M85/M65m/M85m	6-9
Machine torch consumables.....	6-12
Accessory parts.....	6-14
Powermax65/85 labels.....	6-15

Power supply parts

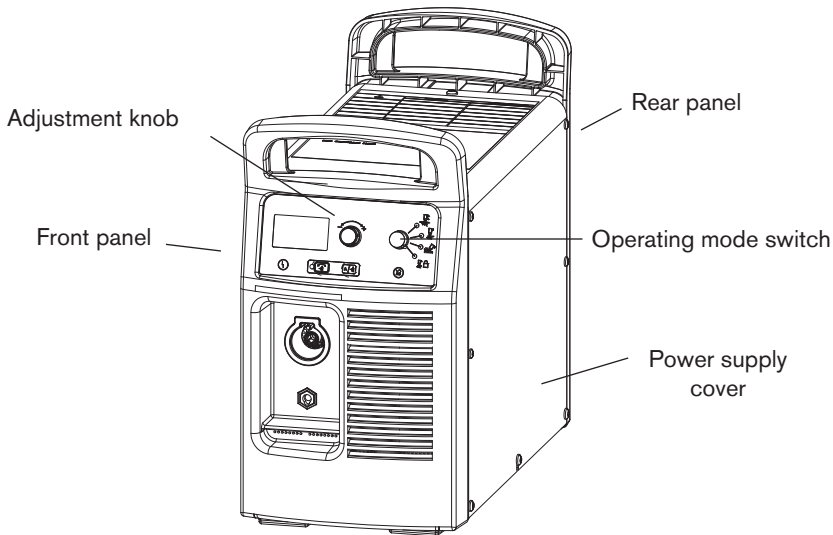

Part number	Description
228643	Kit: Powermax65/85 front panel
228645	Kit: Powermax65 CSA rear panel
228646	Kit: Powermax65 CE rear panel
228647	Kit: Powermax85 CSA rear panel
228653	Kit: Powermax85 CE rear panel
228642	Kit: Powermax65/85 cover screws
228666	Kit: Powermax65 CSA power supply cover
228674	Kit: Powermax65 CE power supply cover
228676	Kit: Powermax85 CSA power supply cover
228675	Kit: Powermax85 CE power supply cover
108797	Adjustment knob
108732	Operating mode switch

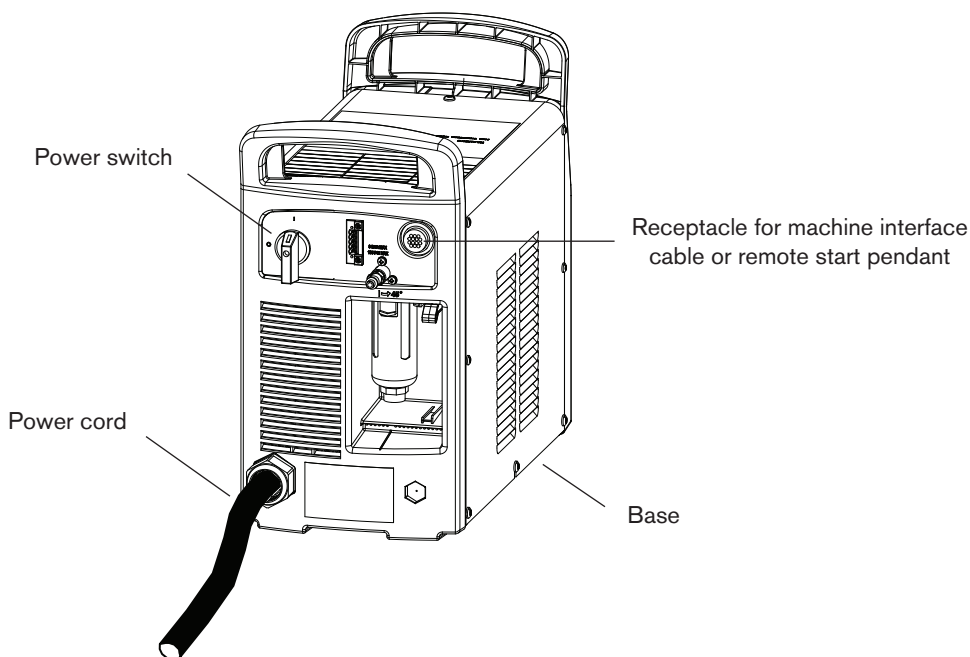

Part number	Description
228691	Kit: Powermax65/85 CSA power cord
228679	Kit: Powermax65 CE power cord
228678	Kit: Powermax85 CE power cord
228680	Kit: Powermax65/85 power cord strain relief
128650	Remote start pendant for machine torch, 25 ft (7.63 m)
128651	Remote start pendant for machine torch, 50 ft (15.24 m)
128652	Remote start pendant for machine torch, 75 ft (22.86 m)
023206	Machine interface cable (start plasma, arc transfer, ground), 25 ft (7.63 m)
023279	Machine interface cable (start plasma, arc transfer, ground), 50 ft (15.24 m)
228350	Machine interface cable (start plasma, arc transfer, adjustable voltage divider, ground), 25 ft (7.6 m), spade connectors
228351	Machine interface cable (start plasma, arc transfer, adjustable voltage divider, ground), 50 ft (15 m), spade connectors
127204	Powermax45/65/85 Machine interface receptacle cover
228539	Kit: RS485 board with cables (65/85)
228697	Kit: PMX65/85 Machine Interface Cable (internal cable w/v-div board)

PARTS

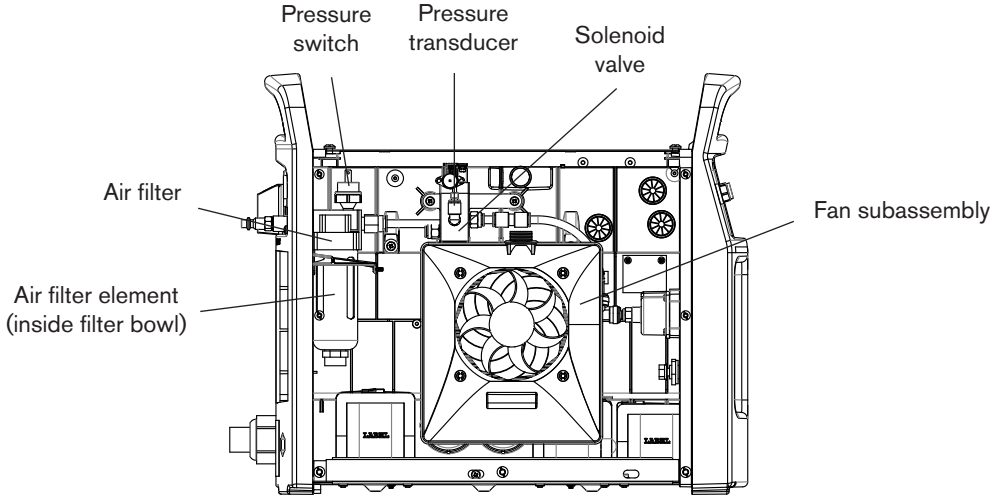

Part number	Description
228686	Kit: Powermax65/85 fan subassembly
228685	Kit: Powermax65/85 air filter
228695	Kit: Powermax65/85 air filter element
228688	Kit: Powermax65/85 pressure switch
228687	Kit: Powermax65/85 solenoid valve
228689	Kit: Powermax65/85 pressure transducer

Hand torch replacement parts

H65/H85

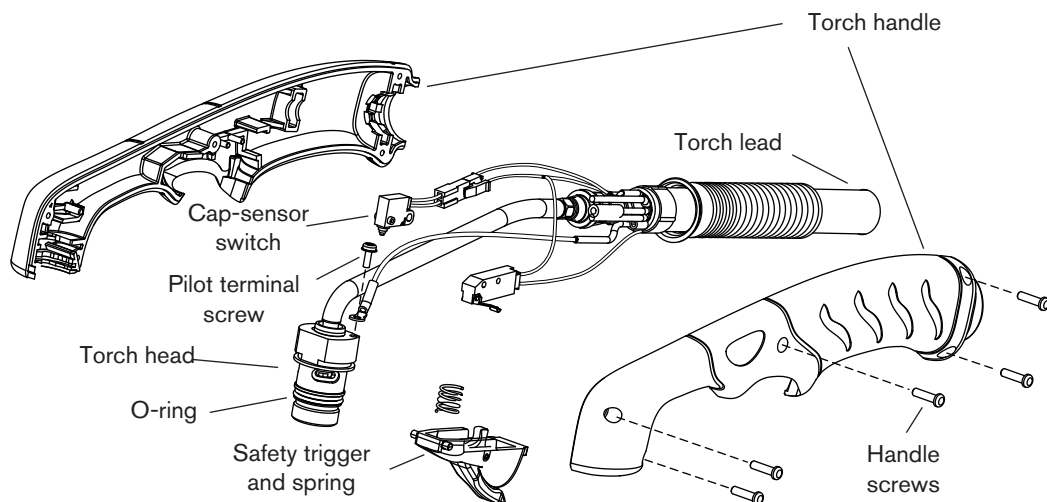

H65s/H85s

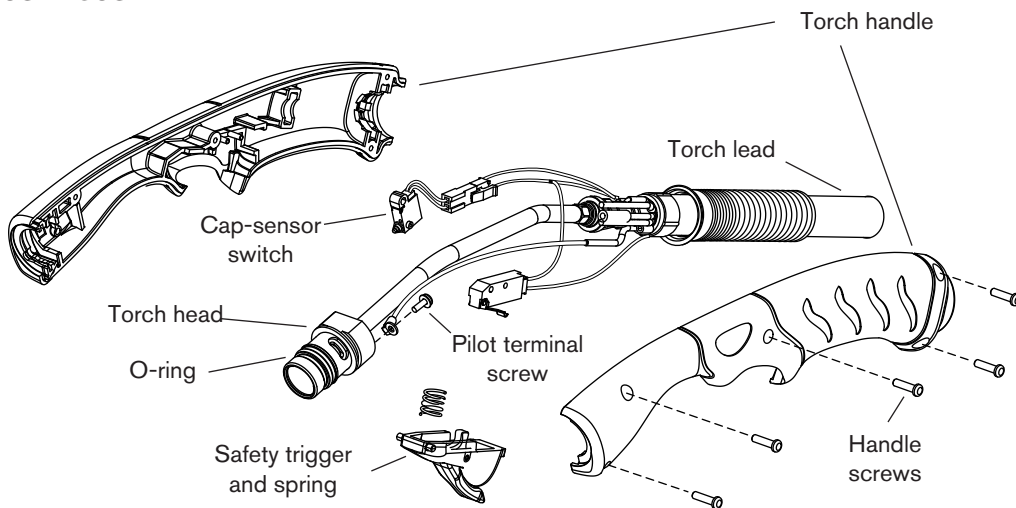

PARTS

The entire hand torch and lead assembly can be replaced, or individual component parts can be replaced. Part numbers starting with 083 and 087 indicate complete torch and lead assemblies.

Part number	Description
083246*	H65 Hand torch assembly with 10 ft (3.0 m) lead
083247*	H65 Hand torch assembly with 25 ft (7.6 m) lead
083248*	H65 Hand torch assembly with 50 ft (15.2 m) lead
083249*	H65 Hand torch assembly with 75 ft (22.9 m) lead
083250*	H65s Hand torch assembly with 10 ft (3.0 m) lead
083251*	H65s Hand torch assembly with 25 ft (7.6 m) lead
083252*	H65s Hand torch assembly with 50 ft (15.2 m) lead
083253*	H65s Hand torch assembly with 75 ft (22.9 m) lead
087084*	H85 Hand torch assembly with 10 ft (3.0 m) lead
087085*	H85 Hand torch assembly with 25 ft (7.6 m) lead
087086*	H85 Hand torch assembly with 50 ft (15.2 m) lead
087087*	H85 Hand torch assembly with 75 ft (22.9 m) lead
087088*	H85s Hand torch assembly with 10 ft (3.0 m) lead
087089*	H85s Hand torch assembly with 25 ft (7.6 m) lead
087090*	H85s Hand torch assembly with 50 ft (15.2 m) lead
087091*	H85s Hand torch assembly with 75 ft (22.9 m) lead
228717	Kit: H65/H85 Torch handle replacement
228718	Kit: H65s/H85s Torch handle replacement
075714	Handle screws, #4 x 1/2 slotted TORX pan head, S/B
228721	Kit: H65/H85/H65s/H85s Safety trigger with spring replacement
228714	Kit: H65/H85 Torch main body replacement
228715	Kit: H65s/H85s Torch main body replacement

* The torch assembly also includes one set of the drag-cutting consumables listed on page 6-8.

Part number	Description
058503	O-ring
075504	Pilot terminal screw
228719	Kit: H65/H85 Cap-sensor switch replacement
228109	Kit: H65s/H85s Cap-sensor switch replacement
228722	Kit: H65/H85 Torch lead replacement, 10 ft (3.0 m)
228723	Kit: H65/H85 Torch lead replacement, 25 ft (7.6 m)
228724	Kit: H65/H85 Torch lead replacement, 50 ft (15.2 m)
228725	Kit: H65/H85 Torch lead replacement, 75 ft (22.9 m)
228726	Kit: H65s/H85s Torch lead replacement, 10 ft (3.0 m)
228727	Kit: H65s/H85s Torch lead replacement, 25 ft (7.6 m)
228728	Kit: H65s/H85s Torch lead replacement, 50 ft (15.2 m)
228729	Kit: H65s/H85s Torch lead replacement, 75 ft (22.9 m)
005252	Trigger start switch

PARTS

Hand torch consumables

Part number	Description
Drag cutting	
220818	Shield
220854	Retaining cap
220941	45 A Nozzle
220819	65 A Nozzle
220816	85 A Nozzle
220842	Electrode
220857	Swirl ring
Gouging	
220798	65 A/85 A shield
220854	Retaining cap
220797	65 A/85 A nozzle
220842	Electrode
220857	Swirl ring
FineCut 45 A	
220931	Deflector
220854	Retaining cap
220930	Nozzle
220842	Electrode
220947	Swirl ring

Machine torch replacement parts

M65/M85/M65m/M85m

Note: This illustration shows the M65/M85 machine torch. The M65m and M85m mini-machine torches do not have a positioning sleeve and gear rack.

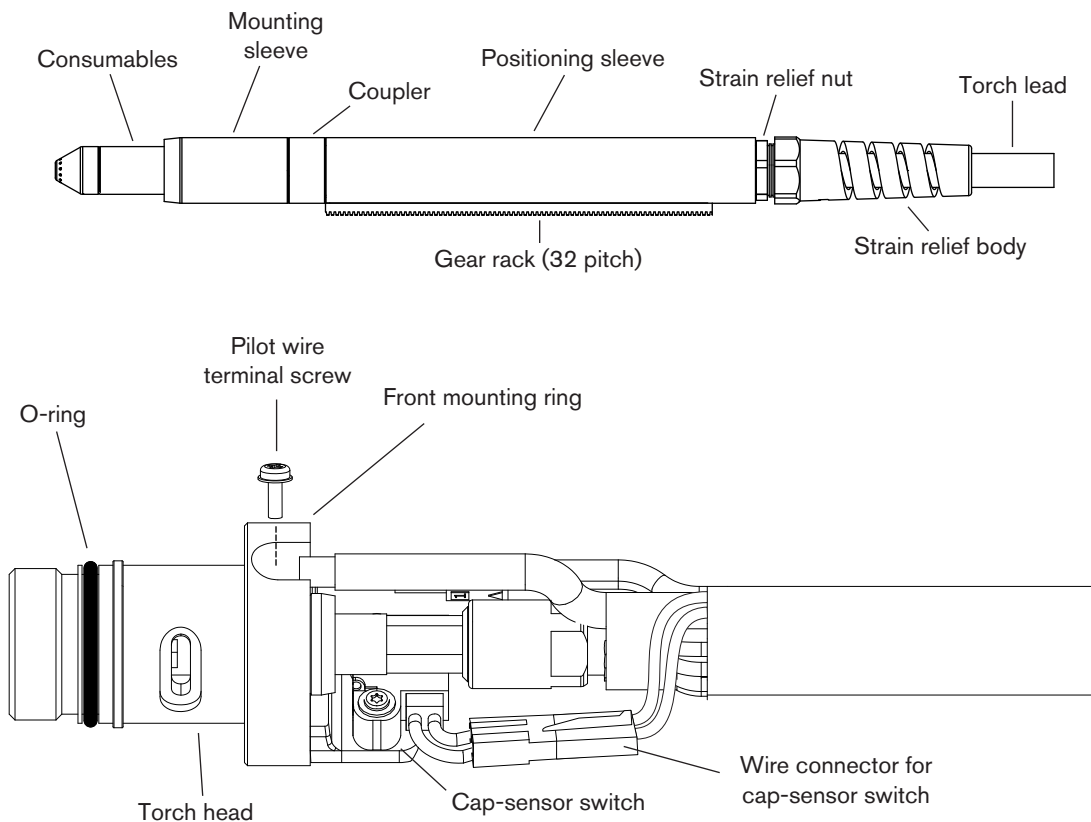

PARTS

The entire machine torch and lead assembly can be replaced, or individual component parts can be replaced. Part numbers starting with 083 and 087 indicate complete torch and lead assemblies.

Part number	Description
083254*	M65 Machine torch assembly with 15 ft (4.6 m) lead
083255*	M65 Machine torch assembly with 25 ft (7.6 m) lead
083256*	M65 Machine torch assembly with 35 ft (10.7 m) lead
083257*	M65 Machine torch assembly with 50 ft (15.2 m) lead
083258*	M65 Machine torch assembly with 75 ft (22.9 m) lead
083259*	M65m Mini-machine torch assembly with 15 ft (4.6 m) lead
083260*	M65m Mini-machine torch assembly with 25 ft (7.6 m) lead
083261*	M65m Mini-machine torch assembly with 35 ft (10.7 m) lead
083262*	M65m Mini-machine torch assembly with 50 ft (15.2 m) lead
083263*	M65m Mini-machine torch assembly with 75 ft (22.9 m) lead
087092*	M85 Machine torch assembly with 15 ft (4.6 m) lead
087093*	M85 Machine torch assembly with 25 ft (7.6 m) lead
087094*	M85 Machine torch assembly with 35 ft (10.7 m) lead
087095*	M85 Machine torch assembly with 50 ft (15.2 m) lead
087096*	M85 Machine torch assembly with 75 ft (22.9 m) lead
087097*	M85m Mini-machine torch assembly with 15 ft (4.6 m) lead
087098*	M85m Mini-machine torch assembly with 25 ft (7.6 m) lead
087099*	M85m Mini-machine torch assembly with 35 ft (10.7 m) lead
087100*	M85m Mini-machine torch assembly with 50 ft (15.2 m) lead
087101*	M85m Mini-machine torch assembly with 75 ft (22.9 m) lead
228737	Kit: M65/M85 positioning sleeve
228738	Kit: M65/M85 removable gear rack
228735	Kit: M65/M65m/M85/M85m front mounting sleeve

* The torch assembly also includes one set of the shielded consumables listed on page 6-12.

Part number	Description
228736	Kit: M65/M65m/M85/M85m adapter ring (coupler)
228716	Kit: M65/M65m/M85/M85m torch main body replacement
228720	Kit: Cap-sensor switch replacement
058503	O-ring
075504	Pilot terminal screw
228730	Kit: M65/M65m/M85/M85m torch lead replacement, 15 ft (4.6 m)
228731	Kit: M65/M65m/M85/M85m torch lead replacement, 25 ft (7.6 m)
228732	Kit: M65/M65m/M85/M85m torch lead replacement, 35 ft (10.7 m)
228733	Kit: M65/M65m/M85/M85m torch lead replacement, 50 ft (15.2 m)
228734	Kit: M65/M65m/M85/M85m torch lead replacement, 75 ft (22.9 m)

PARTS

Machine torch consumables

Part number	Description
Shielded	
220817	Shield
220854	Retaining cap
220953	Ohmic retaining cap
220941	45 A Nozzle
220819	65 A Nozzle
220816	85 A Nozzle
220842	Electrode
220857	Swirl ring
Unshielded	
220955	Deflector
220854	Retaining cap
220941	45 A Nozzle
220819	65 A Nozzle
220816	85 A Nozzle
220842	Electrode
220857	Swirl ring
Gouging	
220798	65 A/85 A shield
220854	Retaining cap
220797	65 A/85 A nozzle
220842	Electrode
220857	Swirl ring

Part number	Description
FineCut 45 A¹	
220955	Deflector
220948	Shield
220854	Retaining cap
220953	Ohmic retaining cap
220930	Nozzle
220842	Electrode
220857	Swirl ring

¹The deflector (220955) is used only with the standard retaining cap (220854). The shield (220948) is used only with the ohmic retaining cap (220953).

Accessory parts

Part number	Description
024548	Leather torch sheathing, 25 ft (7.5 m)
127102	Basic plasma (circles and lines) cutting guide
027668	Deluxe plasma (circles and lines) cutting guide
127301	Powermax65/85 dust cover
128647	Kit: Elimimizer air filter
228570	Kit: Elimimizer air filter with cover
228624	Kit: Elimimizer filter cover
223125	Kit: 65 A Work lead with hand clamp, 25 ft (7.5 m)
223126	Kit: 65 A Work lead with hand clamp, 50 ft (15.2 m)
223127	Kit: 65 A Work lead with hand clamp, 75 ft (22.9 m)
223194	Kit: 65 A Work lead with C-style clamp, 25 ft (7.5 m)
223195	Kit: 65 A Work lead with C-style clamp, 50 ft (15.2 m)
223196	Kit: 65 A Work lead with C-style clamp, 75 ft (22.9 m)
223197	Kit: 65 A Work lead with magnet clamp, 25 ft (7.5 m)
223198	Kit: 65 A Work lead with magnet clamp, 50 ft (15.2 m)
223199	Kit: 65 A Work lead with magnet clamp, 75 ft (22.9 m)
223200	Kit: 65 A Work lead with ring terminal, 25 ft (7.5 m)
223201	Kit: 65 A Work lead with ring terminal, 50 ft (15.2 m)
223202	Kit: 65 A Work lead with ring terminal, 75 ft (22.9 m)
223035	Kit: 85 A Work lead with hand clamp, 25 ft (7.5 m)
223034	Kit: 85 A Work lead with hand clamp, 50 ft (15.2 m)
223033	Kit: 85 A Work lead with hand clamp, 75 ft (22.9 m)
223203	Kit: 85 A Work lead with C-style clamp, 25 ft (7.5 m)
223204	Kit: 85 A Work lead with C-style clamp, 50 ft (15.2 m)
223205	Kit: 85 A Work lead with C-style clamp, 75 ft (22.9 m)

Part number	Description
223206	Kit: 85 A Work lead with magnet clamp, 25 ft (7.5 m)
223207	Kit: 85 A Work lead with magnet clamp, 50 ft (15.2 m)
223208	Kit: 85 A Work lead with magnet clamp, 75 ft (22.9 m)
223209	Kit: 85 A Work lead with ring terminal, 25 ft (7.5 m)
223210	Kit: 85 A Work lead with ring terminal, 50 ft (15.2 m)
223211	Kit: 85 A Work lead with ring terminal, 75 ft (22.9 m)
229370	Kit: Powermax65/85 Wheel kit assembly

Powermax65/85 labels

Part number	Description
228649	Kit: Powermax65 labels, CSA
228650	Kit: Powermax65 labels, CE
228651	Kit: Powermax85 labels, CSA
228652	Kit: Powermax85 labels, CE

The label kits include the consumable label, appropriate safety labels, as well as front and side decals. The consumable and safety labels are pictured on the next page.

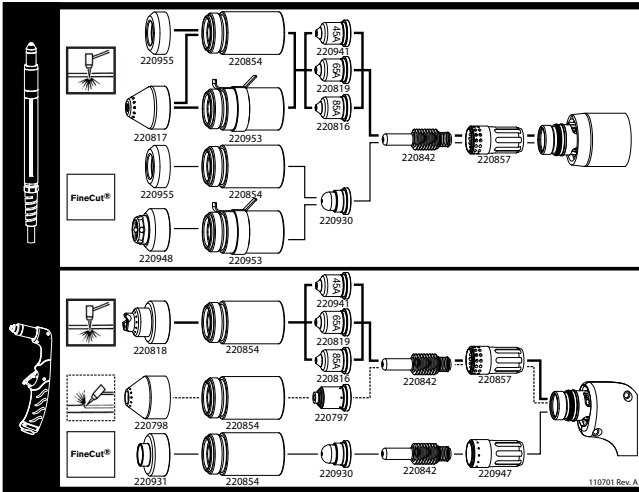

Consumable label



CE safety label

WARNING		AVERTISSEMENT	
<p>Read and follow these instructions, employer safety practices and material safety data sheets (MSDS) for ANSI Z49.1 "Safety in Welding, Cutting and Allied Processes" and American Welding Society (http://www.aws.org) and OSHA Safety and Health Standards, and OSHA (http://www.osha-slc.gov).</p>		<p>Le coupe-plasma peut être préjudiciable pour l'opérateur et les personnes qui travaillent sur les lieux de travail. Consultez le manuel avant de faire fonctionner. Le non-respect des instructions de sécurité peut entraîner la mort.</p>	
<p>Plasma cutting can be injurious to operator and persons in the work area. Consult manual before operating. Failure to follow all these safety instructions can result in death.</p>		<p>Les étincelles de coupe peuvent provoquer une explosion ou un incendie.</p>	
<p>1. Cutting sparks can cause explosion or fire. 1.1 Do not cut near flammable. 1.2 Check a fire extinguisher nearby and ready to use. 1.3 Do not operate in closed spaces. Remove fumes with ventilation.</p>		<p>1. Les étincelles de coupe peuvent provoquer une explosion ou un incendie. 1.1 Ne pas couper près des matières inflammables. 1.2 Vérifiez toujours l'état de présence et prêt à être utilisé. 1.3 Ne pas utiliser un lit ou un autre contenant fermé comme table de coupe.</p>	
<p>2. Plasma arc can injure and burn people the nozzle away from yourself. Arc starts instantly when triggered. 1. Do not place body parts immediately in front of nozzle. 2. Do not grip the workpiece near the cutting path. 3. Wear complete body protection.</p>		<p>2. L'arc plasma peut tisser et brûler déloger le buse de soi. Il s'allume instantanément quand on l'amorçait. 2.1 Couper l'alimentation avant de déloger le buse. 2.2 Ne pas avoir la main à couper de la trajectoire de coupe. 2.3 Se protéger entièrement le corps.</p>	
<p>3. Hazardous voltage. Risk of electric shock or burn. 3.1 Wear insulating gloves. Replace gloves when wet or damaged. 3.2 Protect from shock by instantly grounded from work and ground. 3.3 Disconnect power before servicing. Do not touch live parts.</p>		<p>3. Tension dangereuse. Risque de choc électrique ou de brûlure. 3.1 Porter des gants isolants. Remplacer les gants s'ils sont humides ou endommagés. 3.2 Se protéger contre les chocs en reliant de la machine et de la terre. 3.3 Couper l'alimentation avant l'entretien. Ne pas toucher les pièces sous tension.</p>	
<p>4. Plasma fumes can be hazardous. 4.1 Do not inhale fumes. 4.2 Do not operate in closed spaces. Remove fumes with ventilation.</p>		<p>4. Les fumées plasma peuvent être dangereuses. 4.1 Ne pas inhaler des fumées. 4.2 Ne pas couper dans des espaces clos. Chasser les fumées par ventilation.</p>	
<p>5. Arc rays can burn eyes and injure skin. 5.1 Wear correct and appropriate protective equipment to protect head, eyes, ears, hands, and body. Before start cutting, protect ears from noise. Use hearing helmet with the correct shade of filter.</p>		<p>5. Les rayons d'arc peuvent brûler les yeux et blesser la peau. 5.1 Porter un bon équipement de protection pour se protéger la tête, les yeux, les oreilles, les mains et le corps. Écarter le ciel de la chambre. Protéger les oreilles contre le bruit. Utiliser un masque de soudeur avec un filtre de nuance appropriée.</p>	
<p>6. Become labeled. Only qualified personnel should operate the equipment. Keep non-qualified personnel and children away.</p>		<p>6. Suivre une formation. Seul le personnel qualifié a le droit de faire fonctionner cet équipement. Le personnel non qualifié et les enfants doivent être tenus à l'écart.</p>	
<p>7. Do not remove, destroy, or cover this label. Repaste it in missing, damaged, or worn (PN 110204 Rev A).</p>		<p>7. Ne pas enlever, détruire ni couvrir cette étiquette. Ne remplacez-la que si elle est manquante, endommagée ou usée (PN 110204 Rev A).</p>	

CSA safety label